

Quicke

REDSKAP PRISLISTE JULI 2022

Fra 1. juli 2022

Ålø Norge AS

Televeien 12, 1890 Rakkestad

Tel: 69 222 888

post@alo.no

www.quirke.no

**OPPDATERT:
APRIL 2024**



2024-04-04

Klikk på Quicke for å komme tilbake til denne side

Klikk på ønsket linje og du kommer direkte til siden.

INNHOOLD

Generell informasjon	3
Fraktkostnader	4
Kontakt informasjon	5
Krok oversikt	6
Oversikt over Neste Generasjon Skuffer	7
Overgangsliste for utgående skuffe modeller	8
Skuff Type S: Jord Skuff	10
Skuff Type G: Universal skuff	12
Skuff Type V: Volum Skuff	16
Compact & Utility Skuffer	20
Spesialskuffer	22
Siloredskap	26
Gjødselredskap	40
Balleredskap	42
Løfteredskaper: Pallegaffel og storsekkløft	52
Stengrep	58
Motvekt & Adaptere	60
Skrubare kroker - Bolt on Hooks	62
Artikkelliste kroksatser	64
Oversikt over kroksystemer og krokguide	67

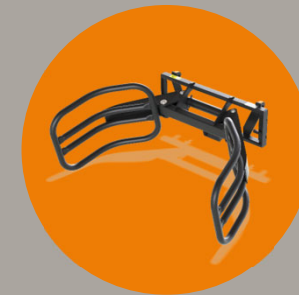
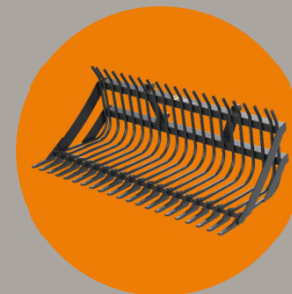

Priser:

Alle priser er opplyst i norske kroner (NOK), eksklusive moms og frakt.

Garantitid

12 måneder

Betalingsbetingelser

Standard 30 dager netto eksklusive moms. Disse vilkår gjelder kun etter godkjent kreditprøving.

Returer

Ved retur/feilbestilling krediteres 80 % av varens verdi, forutsatt at returen i forkant er godkjent av Ålø Norge AS/Ålö AB. Returskjema oversendt fra Ålø Norge AS/Ålö AB skal benyttes ved retur av varer. Returfrakten betales av sender.

Reklamasjon/Ankomstkontroll

Eventuelle reklamasjoner på transportskade meldes til Ålø Norge AS/Ålö AB senest innen 3 dager fra varens ankomst.

Forsinkelsesrente:

Rente og lovpålagt purregebyr belastes fra forfalldato.

Leveringsvilkår

Free Carrier (FCA) i h.h. til Incoterms 2010

Fraktkostnader:

Frakt tilkommer og faktureres etter gjeldende fraktprisliste.

Våre fullstendige generelle vilkår finner du på vår hjemmeside. www.quicke.no – Klikk på FORHANDLERE - KONTAKT - DOKUMENTER

Denne prisliste erstatter alle tidligere prislister fra Ålø Norge AS/Ålö AB

Ålø Norge AS/Ålö AB tar forbehold om eventuelle skrivefeil, produktendringer, prisjusteringer og andre endringer i denne prisliste.

Frontlaster	Sone 1	Sone 2
1 stk frontlaster / frontlasterpakke:	2 100 kr	4 000 kr
2 stk frontlaster / frontlasterpakke:	3 500 kr	6 500 kr
3 stk eller flere frontlaster / frontlasterpakke:	+ 1 300 kr per pakke	+ 2 000 kr per pakke
Fundament	Sone 1	Sone 2
1 stk fundament:	1 200 kr	2 200 kr
2 stk fundament:	2 200 kr	3 300 kr
3 stk eller flere fundament:	+ 1 000 kr per fundament	+ 1 100 kr per fundament
Hydraulikksatser, slangesatser og tilbehør	Sone 1	Sone 2
Hydraulikksatser / Slangesatser:	600 kr	1 000 kr
Tilbehørssatser:	500 kr	900 kr
Redskap med eller uten krok	Sone 1	Sone 2
1 stk redskap:	700 kr	1 500 kr
2 stk redskap:	1 300 kr	2 200 kr
3 stk redskap:	1 800 kr	2 900 kr
4 stk redskap:	2 200 kr	3 600 kr
5 stk redskap eller flere:	Fraktfritt	Fraktfritt
Redskapskroker / tilbehør	Sone 1	Sone 2
1 stk kroksats:	500 kr	800 kr
2 stk kroksatser:	800 kr	1 100 kr
3 stk kroksatser eller flere:	Fraktfritt	Fraktfritt

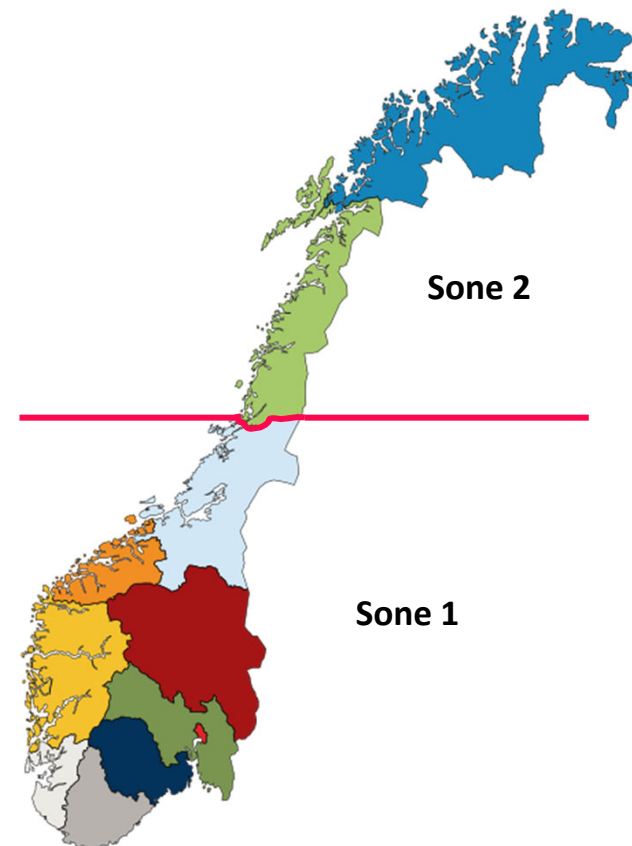

FRI FRAKT PÅ REDSKAP GJELDER KUN VED SAMLET LEVERING TIL EN DESTINASJON

Det gis ingen rabatt på frakt

Ålø Norge ble startet januar 1985. Vi selger og markedsfører Quicke frontlastere samt tilhørende redskaper på det norske markedet.

Selskapet er et datterselskap av Ålö AB i Sverige.

Vi i Ålø Norge AS bestreber oss hele tiden for å bli enda bedre til å betjene markedet:

HOVED NUMMER ÅLØ NORGE: 69 222 888

BESTILLINGER SENDES TIL POST@ALO.NO

FINN BRÄNNVALL
DAGLIG LEDER



Telefon: +46 70 3016523
E-post: finn.brannvall@alo.se

LEIF-ARNE BØHN
DISTRIKSANSVARLIG SELGER



Telefon: 91 69 14 22
E-post: leif-arne.bohn@alo.no

PER KRISTIAN HOLØS
PRODUKTANSVARLIG / TEKNISK



Telefon: 47 63 10 02
E-post: per.kristian.holos@alo.no

JAN-ERIK AASERUD
SALG / RESERVEDELER



Telefon: 96 00 36 19
E-post: jan-erik.aaserud@alo.no

SONDRE MARTINSEN
SALG / LOGISTIKK



Telefon: 46 70 21 24
E-post: sondre.martinsen@alo.no

OLAV NØSTVEDT
SALG / RESERVEDELER



Telefon: 93 64 00 79
E-post: olav.nostvedt@alo.no

Ett stort antall kroker for mange ulike maskiner

Quicke

Mange Quicke-redskap kan leveres med sveisede Euro-kroker og SMS-kroker. Foruten sveisede kroker så kan vi til de fleste redskap, som i prislisten er markert med BoH, levere de med fastskrudde kroker.

Redskap med skrudde kroker har en basispris. Deretter tillegges prisen for kroksats, eventuell slangesats og tilbehør til basisprisen.

Totalt så har vi 7 forskjellige kroksystem og fire ulike prisgrupper.

KROKSYSTEM OG PRISGRUPPEE

KROKSYSTEM		PRISGRUPPE	
		A	B
BoH 40x80	40 x 80	2 100 kr	3 800 kr
BoH 60x80	60 x 80	2 100 kr	3 800 kr
BoH 80x80	80 x 80	2 100 kr	3 800 kr
BoH Rail S/L	Rail S/L	3 800 kr	
BoH M24	M24	5 200 kr	
BoH 80x80XL	80 x 80 XL	5 200 kr	
BoH M16 S/L	M16 S M16 L	2 100 kr 3 300 kr	

Lengst bak i denne prisliste finner du vår krokguide. Der kan du se alle kroker og hvilket BoH-kroksystem vi tilbyr kroken i.

Artikkelnummerliste
kroksatser se side 62



QUICKE CONFIGURATOR – DITT VIKTIGSTE VERKTØY
RIKTIG KONFIGURERING AV REDSKAP TIL DIN MASKIN FINNER DU PÅ
(Ta kontakt om du behøver tilgang/ hjelp til å komme i gang)





- ! Quicke tilbyr både sveisede og skrudde kroker.(BoH).
- ! Quicke tilbyr et bredt utvalg av kroktyper til forskjellige lastemaskiner og traktorer. Det er også tatt fram spesial kroker mot Z linker, store hjul og begrensede oppbrytningsvinkler.
- ! Quicke benytter moderne teknikk for å sikkerhetsstille at din skuffe får en perfekt passform og funksjon på din bæremaskin.
- ! Quicke tilbyr forskjellige løse slitestål som enkelt kan ettermonteres. Her er det gjenger i slitestålet slik at man slipper muttere og forenkler montering.
- ! Quicke tilbyr en forhøynings plate som kan ettermonteres på skuffene. Dette sikrer at ikke masser renner over og ned i redskapsfestet og på sylindre.
- ! Quicke tilbyr slitesko i slitesterk plast som kan monteres på sideveggene på skuffa. Dette hindrer kjøreskader på betong og andre materialer.

- 1 Konisk design sikrer rask og effektiv tømning, og at massene slipper lettere ut.
- 2 En tverrgående innebygd bjelke og dobbel bunn sikrer tunge belastninger, samtidig som det gir muligheter for et solid gjenge parti til skrukrokene (M16 og M24, avhengig av modell)
- 3 500 brinell i slitestålet i front, og de tverrgående sliteplatene i bunn seksjonen gjør at skuffa har stor slitestyrke og takler store belastninger på en fantastisk måte.
- 4 Store forsterkningsplater i rygg partiet overfører all kraft fra maskinen til skuffa.
- 5 Alle våre redskap er pulverlakkerte hvilket gir en hard og slitesterk overflate.

Uansett om det er en traktor, kompakt laster eller teleskop/hullaster kan du være sikker på at du finner den perfekte skuffe som passer dine behov og maskin. Med flere krok typer tilgjengelig tilbyr Quicke ett stort utvalg til deg og din maskin. Quicke passer alltid.

Størrelse og egenskaper

TYPE S	TYPE G	TYPE V
JORD	UNIVERSAL	VOLUM
		
SXL+	GXL+	VXL+
SL+	GL+	VL+
SM+	GM+	VL
SM	GM	VM
–	GS+	–
–	GS	VS

Type skuffer



UTGÅTTE SKUFFE MODELLER TIL DAGENS MODELLER

SKUFFE TYPE-S SOIL (JORD/GRUS)

S

Utgått Modell		Dagens Modell	
Serie	Model	Soil Type - S	Modell
HDXL	270, 290	SXL+	275, 295
HDXL	220, 240, 260	SL+	220, 240, 265
HD	185, 210, 240, 260	SM+	160, 180, 200, 220, 240, 260
HT	135, 160, 185, 210	SM+	
S	185, 210	SM	185, 210

SKUFFE TYPE-G GENERAL (UNIVERSAL)

G

Utgått Modell		Dagens Modell	
Serie	Model	General Type - G	Modell
HDX Large	1921, 2023, 2124	GXL+	200, 220, 240, 260
HDX Medium	1421, 1523, 1624	GL+	180, 200, 220, 240, 260
HDX Small	1021, 1123, 1224	GM+	180, 200, 220, 240
H	135, 160, 185, 210, 240	GM	140, 165, 185, 215, 245
		GS+	90, 110, 120, 140, 160
L	130, 180	GS	135, 185

SKUFFE TYPE-V VOLUME

V

Utgått Modell		Dagens Modell	
Serie	Model	Volum Type - V	Modell
XV	240, 260, 280, 300	VXL+	245, 265, 285, 305
		VL+	180, 200, 220, 240, 260
HV / HDV	200, 220, 240, 260	VL	205, 225, 245, 265
HXV	180, 200, 220, 240, 260	VM	185, 205, 225, 245, 265
LV	200, 220	VS	200, 220



MPU 160 EURO



XH 220

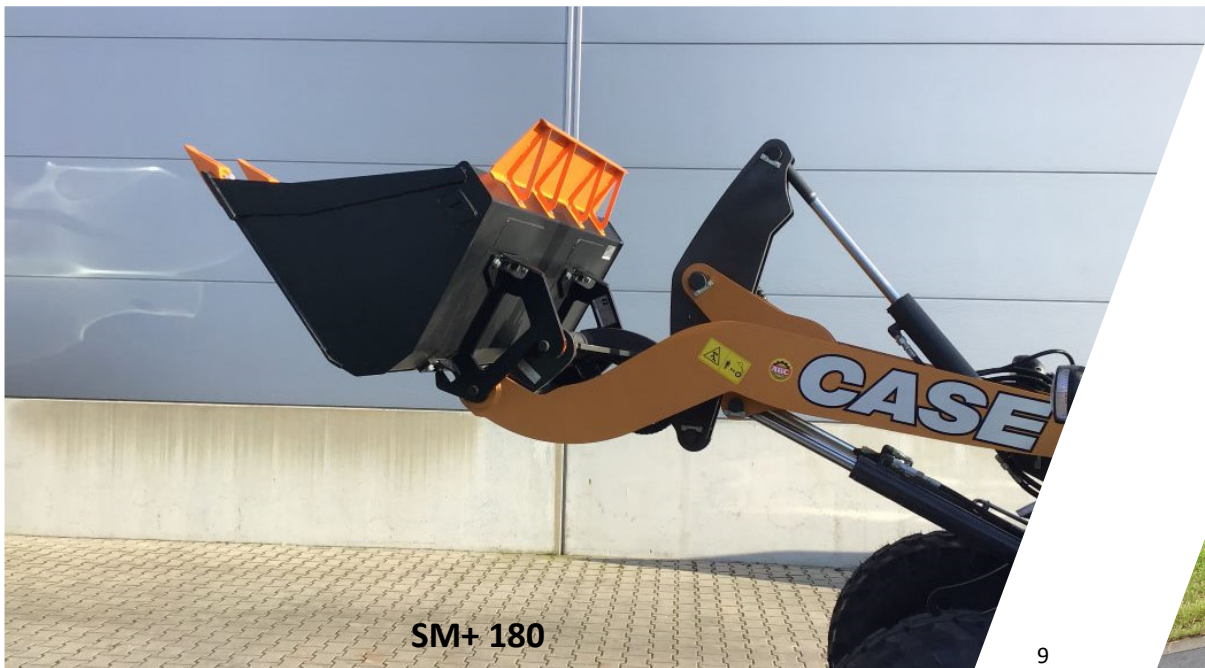

SM+ 180



GS+ 120

TYPE S (JORD) SKUFFE

Quicke

SXL+ SKUFFE			275	295
	Bredde	cm	271	291
	Dybde	cm	129	129
	Høyde	cm	133	133
	Volum råga	m ³	2.50	2.70
	Volum strøken	m ³	2.00	2.10
	Vekt	kg	1158	1216
	PRIS: Uten krok		58 500	64 300
Kroksats		5 200		
Skjærstål 500 HB		8 100	8 700	
Påskrubare tenner		6 300	7 100	
Spill beskyttelse L+ / XL+		2 000	2 000	

BoH
M24

SXL+ skuff erstatter HDXL skuff

SM+ SKUFFE			160	180	200	220	240	260
	Bredde	cm	158	178	198	218	238	258
	Dybde	cm	89	89	89	89	89	89
	Høyde	cm	75,5	75,5	75,5	75,5	75,5	75,5
	Volum råga	m ³	0.76	0.86	1.00	1.06	1.16	1.26
	Volum strøken	m ³	0.60	0.68	0.76	0.84	0.90	1.00
	Vekt	kg	235	256	277	302	369	392
	PRIS: Sveiset krok		12 200	14 300	15 600	16 400	20 300	22 500
PRIS: Uten krok		10 900	13 100	14 400	15 200	19 100	21 300	
Kroksats		3 300						
Skjærstål 500 HB		4 400	4 900	5 200	5 800	6 100	6 400	
Skjærstål plast		6 400	7 200	7 600	8 300	9 000	9 800	
Isriverstål		5 100	5 700	5 900	6 300	7 000	7 300	
Påskrubare tenner		3 100	3 100	3 300	3 300	3 900	4 300	
Spill beskyttelse M+		1 800	1 800	1 800	1 800	1 800	1 800	

Euro
SMS

BoH
M16 L

SM+ skuff erstatter HD skuff

SL+ SKUFFE			220	240	265
	Bredde	cm	217	237	262
	Dybde	cm	105	105	120
	Høyde	cm	112	112	123
	Volum råga	m ³	1.30	1.40	2.00
	Volum strøken	m ³	1.00	1.10	1.60
	Vekt	kg	634	669	789
	PRIS: Uten krok		30 100	35 700	38 700
Kroksats		5 200			
Skjærstål 500 HB		7 000	7 300	7 800	
Påskrubare tenner		4 300	4 800	5 400	
Spill beskyttelse L+ / XL+		2 000	2 000	2 000	

BoH
M24

SL+ skuff erstatter HDXL skuff

Artikkelnummerliste
kroksatser se side 64

TYPE S (JORD) SKUFFE

Redskap	Art.nr.	Kroktyp	Pris
Skuffe SXL+/SL+			
Skuffe SXL+ 275	11255637Q	uten krok	58 500
Skuffe SXL+ 290	11255638Q	uten krok	64 300
Skuffe SL+ 220	11255639Q	uten krok	30 100
Skuffe SL+ 240	11255640Q	uten krok	35 700
Skuffe SL+ 265	11255641Q	uten krok	38 700
Tilbehør SL+/SXL+			
Skjærstålsats SL+ 220	11255782Q		7 000
Skjærstålsats SL+ 240	11255783Q		7 300
Skjærstålsats SL+ 265	11255784Q		7 800
Skjærstålsats SXL+ 275	11255785Q		8 100
Skjærstålsats SXL+ 290	11255786Q		8 700
Tannsats SL+ 220	11255414Q		4 300
Tannsats SL+ 240	11255417Q		4 800
Tannsats SL+ 265	11255418Q		5 400
Tannsats SXL+ 275	11255419Q		6 300
Tannsats SXL+ 290	11255420Q		7 100
Spill beskyttelse L+ / XL+	11256106Q		2 000
Skuffe SM+			
Skuffe SM+ 160	11255557Q	uten krok	10 900
Skuffe SM+ 160	11255594Q	Euro	12 200
Skuffe SM+ 160	11256356Q	SMS	12 200
Skuffe SM+ 180	11255556Q	uten krok	13 100
Skuffe SM+ 180	11255596Q	Euro	14 300
Skuffe SM+ 180	11256357Q	SMS	14 300
Skuffe SM+ 200	11255555Q	uten krok	14 400
Skuffe SM+ 200	11255598Q	Euro	15 600
Skuffe SM+ 200	11256358Q	SMS	15 600
Skuffe SM+ 220	11255554Q	uten krok	15 200
Skuffe SM+ 220	11255600Q	Euro	16 400
Skuffe SM+ 220	11255601Q	SMS	16 400

Redskap	Art.nr.	Kroktyp	Pris
Skuffe SM+ 240	11255553Q	uten krok	19 100
Skuffe SM+ 240	11255602Q	Euro	20 300
Skuffe SM+ 240	11255603Q	SMS	20 300
Skuffe SM+ 260	11255552Q	uten krok	21 300
Skuffe SM+ 260	11255604Q	Euro	22 500
Skuffe SM+ 260	11255605Q	SMS	22 500
Tilbehør SM+			
Skjærstålsats SM+ 160	11255535Q		4 400
Skjærstålsats SM+ 180	11255493Q		4 900
Skjærstålsats SM+ 200	11255494Q		5 200
Skjærstålsats SM+ 220	11255495Q		5 800
Skjærstålsats SM+ 240	11255496Q		6 100
Skjærstålsats SM+ 260	11255497Q		6 400
Isriverstål SM+ 160	11255536Q		5 100
Isriverstål SM+ 180	11255499Q		5 700
Isriverstål SM+ 200	11255501Q		5 900
Isriverstål SM+ 220	11255502Q		6 300
Isriverstål SM+ 240	11255503Q		7 000
Isriverstål SM+ 260	11255504Q		7 300
Skjærstålsats plast SM+ 160	11255537Q		6 400
Skjærstålsats plast SM+ 180	11255505Q		7 200
Skjærstålsats plast SM+ 200	11255506Q		7 600
Skjærstålsats plast SM+ 220	11255507Q		8 300
Skjærstålsats plast SM+ 240	11255508Q		9 000
Skjærstålsats plast SM+ 260	11255509Q		9 800
Tannsats SM+ 160-180	11255726Q		3 100
Tannsats SM+ 200-220	11255727Q		3 300
Tannsats SM+ 240	11255728Q		3 900
Tannsats SM+ 260	11255729Q		4 300
Spill beskyttelse M+	11256105Q		1 800

TYPE G (UNIVERSAL) SKUFFE

Quicke

GXL+ SKUFFE			200	220	240	260
	Bredde	cm	198	218	238	258
	Dybde	cm	136.5	136.5	136.5	136.5
	Høyde	cm	101.5	101.5	101.5	101.5
	Volum råga	m ³	1.75	1.94	2.11	2.31
	Volum strøken	m ³	1.40	1.55	1.69	1.85
	Vekt	kg	497	529	588	619
	PRIS: Uten krok		23 700	24 500	25 300	25 900
	Kroksats		5 200			
Skjærstål 500 HB		5 200	5 800	6 100	6 400	
Skjærstål plast		7 600	8 300	9 000	9 800	
Isriverstål		5 900	6 300	7 000	7 300	
Side beskyttelse		1 600	1 600	1 600	1 600	
Spill beskyttelse L+ / XL+		2 000	2 000	2 000	2 000	

BoH
M24

GM+ SKUFFE			180	200	220	240
	Bredde	cm	178	198	218	238
	Dybde	cm	104.5	104.5	104.5	104.5
	Høyde	cm	78	78	78	78
	Volum råga	m ³	1.02	1.14	1.27	1.40
	Volum strøken	m ³	0.81	0.90	0.99	1.09
	Vekt	kg	300	324	357	380
	PRIS: Uten krok		16 500	17 200	18 500	19 200
	Kroksats		3 300			
Skjærstål 500 HB		4 900	5 200	5 800	6 100	
Skjærstål plast		7 200	7 600	8 300	9 000	
Isriverstål		5 700	5 900	6 300	7 000	
Side beskyttelse		1 600	1 600	1 600	1 600	
Spill beskyttelse M+		1 800	1 800	1 800	1 800	

BoH
M16 L

GL+ SKUFFE			180	200	220	240	260
	Bredde	cm	178	198	218	238	258
	Dybde	cm	124.5	124.5	124.5	124.5	124.5
	Høyde	cm	90.5	90.5	90.5	90.5	90.5
	Volum råga	m ³	1.23	1.40	1.55	1.71	1.90
	Volum strøken	m ³	1.00	1.12	1.25	1.37	1.50
	Vekt	kg	420	448	473	529	558
	PRIS: Uten krok		17 500	18 900	20 400	21 600	22 900
	Kroksats		5 200				
Skjærstål 500 HB		4 900	5 200	5 800	6 100	6 400	
Skjærstål plast		7 200	7 600	8 300	9 000	9 800	
Isriverstål		5 700	5 900	6 300	7 000	7 300	
Side beskyttelse		1 600	1 600	1 600	1 600	1 600	
Spill beskyttelse L+ / XL+		2 000	2 000	2 000	2 000	2 000	

BoH
M24

GM SKUFFE			140	165	190	215	245
	Bredde	cm	138	163	188	213	243
	Dybde	cm	81.5	81.5	81.5	81.5	81.5
	Høyde	cm	71.5	71.5	71.5	71.5	71.5
	Volum råga	m ³	0.54	0.65	0.72	0.82	0.95
	Volum strøken	m ³	0.45	0.54	0.60	0.69	0.79
	Vekt	kg	146	165	205	251	293
	PRIS: Sveiset krok		10 200	10 700	11 500	13 500	17 200

Euro
SMS

GM skuffe erstatter H skuffe

Artikkelnummerliste
kroksatser se side 64

TYPE G (UNIVERSAL) SKUFFE



Redskap	Art.nr.	Kroktyp	Pris
Skuffe GXL+/GL+/GM+			
Skuffe GXL+ 200	11255477Q	uten krok	23 700
Skuffe GXL+ 220	11255478Q	uten krok	24 500
Skuffe GXL+ 240	11255327Q	uten krok	25 300
Skuffe GXL+ 260	11255479Q	uten krok	25 900
Skuffe GL+ 180	11255475Q	uten krok	17 500
Skuffe GL+ 200	11255474Q	uten krok	18 900
Skuffe GL+ 220	11255473Q	uten krok	20 400
Skuffe GL+ 240	11255411Q	uten krok	21 600
Skuffe GL+ 260	11255476Q	uten krok	22 900
Skuffe GM+ 180	11255548Q	uten krok	16 500
Skuffe GM+ 200	11255549Q	uten krok	17 200
Skuffe GM+ 220	11255550Q	uten krok	18 500
Skuffe GM+ 240	11255551Q	uten krok	19 200
Tilbehør GM+/GL+/GXL+			
Skjærstålsats GL+/GM+ 180	11255493Q		4 900
Skjærstålsats GXL+/GL+/GM+ 200	11255494Q		5 200
Skjærstålsats GXL+/GL+/GM+ 220	11255495Q		5 800
Skjærstålsats GXL+/GL+/GM+ 240	11255496Q		6 100
Skjærstålsats GXL+/GL+/GM+ 260	11255497Q		6 400
Isriverstål GL+/GM+ 180	11255499Q		5 700
Isriverstål GXL+/GL+/GM+ 200	11255501Q		5 900
Isriverstål GXL+/GL+/GM+ 220	11255502Q		6 300
Isriverstål GXL+/GL+/GM+ 240	11255503Q		7 000
Isriverstål GXL+/GL+/GM+ 260	11255504Q		7 300
Skjærstålsats plast GL+/GM+ 180	11255505Q		7 200
Skjærstålsats plast GXL+/GL+/GM+ 200	11255506Q		7 600
Skjærstålsats plast GXL+/GL+/GM+ 220	11255507Q		8 300
Skjærstålsats plast GXL+/GL+/GM+ 240	11255508Q		9 000
Skjærstålsats plast GXL+/GL+/GM+ 260	11255509Q		9 800
Side beskyttelse GXL+/GL+/GM+ 180-260	11255516Q		1 600
Spill beskyttelse M+	11256106Q		1 800
Spill beskyttelse L+ / XL+	11256105Q		2 000

Redskap	Art.nr.	Kroktyp	Pris
Skuffe GM			
Skuffe GM 140	11255845Q	Euro	10 200
Skuffe GM 140	11255850Q	SMS	10 200
Skuffe GM 165	11255861Q	Euro	10 700
Skuffe GM 165	11255863Q	SMS	10 700
Skuffe GM 190	11255563Q	Euro	11 500
Skuffe GM 190	11255866Q	SMS	11 500
Skuffe GM 215	11255867Q	Euro	13 500
Skuffe GM 215	11255869Q	SMS	13 500
Skuffe GM 245	11255514Q	Euro	17 200
Skuffe GM 245	11255871Q	SMS	17 200

TYPE G (UNIVERSAL) SKUFFE

Quicke

GS+ SKUFFE			90	100	120	140	160
	Bredde	cm	88	98	118	138	158
	Dybde	cm	82.5	82.5	82.5	82.5	82.5
	Høyde	cm	64.5	64.5	64.5	64.5	64.5
	Volum råga	m ³	0.32	0.36	0.44	0.53	0.61
	Volum strøken	m ³	0.26	0.29	0.36	0.42	0.48
	Vekt	kg	108	116	134.5	180.5	197
	PRIS: Uten krok			6 500	7 300	8 600	9 800
Kroksats			2 100		3 300		
<div style="border: 1px solid black; border-radius: 10px; padding: 2px; display: inline-block;"> BoH M16 S/L </div>	Skjærstål 500 HB		2 200	2 500	2 900	3 300	3 700
	Skjærstål plast		3 600	4 300	4 900	5 700	6 100
	Isriverstål		2 600	2 900	3 200	3 900	4 200
	Side beskyttelse		1 600	1 600	1 600	1 600	1 600
	Spill beskyttelse S+		N/A	1 000	1 000	1 000	1 000

GS SKUFFE			135	185
	Bredde	cm	137	187
	Dybde	cm	78.4	78.4
	Høyde	cm	79	79
	Volum råga	m ³	0.51	0.71
	Volum strøken	m ³	0.40	0.60
	Vekt	kg	126	166
PRIS: Sveiset krok			7 000	8 300

Euro SMS

GS skuffe erstatter L skuff

* M16L-kroken anbefales på størrelse 140 og 160



Artikkelnummerliste
kroksatser se side 64

TYPE G (UNIVERSAL) SKUFFE

Redskap	Art.nr.	Kroktyp	Pris
Skuffe GS+			
Skuffe GS+ 90	11255530Q	uten krok	6 500
Skuffe GS+ 100	11255531Q	uten krok	7 300
Skuffe GS+ 120	11255532Q	uten krok	8 600
Skuffe GS+ 140	11255533Q	uten krok	9 800
Skuffe GS+ 160	11255534Q	uten krok	10 800
Tilbehør GS+			
Skjærstålsats GS+ 90	11255524Q		2 200
Skjærstålsats GS+ 100	11255525Q		2 500
Skjærstålsats GS+ 120	11255527Q		2 900
Skjærstålsats GS+ 140	11255528Q		3 300
Skjærstålsats GS+ 160	11255529Q		3 700
Isriverstål GS+ 90	11255538Q		2 600
Isriverstål GS+ 100	11255539Q		2 900
Isriverstål GS+ 120	11255540Q		3 200
Isriverstål GS+ 140	11255541Q		3 900
Isriverstål GS+ 160	11255542Q		4 200
Skjærstålsats plast GS+ 90	11255547Q		3 600
Skjærstålsats plast GS+ 100	11255546Q		4 300
Skjærstålsats plast GS+ 120	11255545Q		4 900
Skjærstålsats plast GS+ 140	11255544Q		5 700
Skjærstålsats plast GS+ 160	11255543Q		6 100
Side beskyttelse GS+ 90-160	11255516Q		1 600
Spill beskyttelse S+	11256175Q		1 000

Redskap	Art.nr.	Kroktyp	Pris
Skuffe GS			
Skuffe GS 135	11255515Q	Euro	7 000
Skuffe GS 135	11255899Q	SMS	7 000
Skuffe GS 185	11255900Q	Euro	8 300
Skuffe GS 185	11255901Q	SMS	8 300

TYPE V (VOLUM) SKUFFE

Quicke

VXL+ SKUFFE			245	265	285	305
	Bredde	cm	244	261	283	302
	Dybde	cm	156	156	171	171
	Høyde	cm	124	124	132	147
	Volum råga	m ³	3.00	3.20	4.00	5.00
	Volum strøken	m ³	2.40	2.60	3.20	4.00
	Vekt	kg	727	761	1120	1313
	PRIS: Uten kroker		30 100	35 700	45 900	65 600
Kroksats			5 200			
Skjærstål 500 HB		7 500	7 900	8 300	8 900	
Skjærstål plast		11 100	11 600	12 500	13 000	
Isriverstål		8 100	8 600	9 100	9 600	
Side beskyttelse		2 200	2 200	2 200	2 200	
Spill beskyttelse L+ / XL+		2 000	2 000	2 000	2 000	
Dekkeplate for siktvindu		1 000	1 000	1 000	1 000	

BoH
M24

VL+ SKUFFE			180	200	220	240	260
	Bredde	cm	178	198	218	238	258
	Dybde	cm	107.5	107.5	107.5	124.5	124.5
	Høyde	cm	96	96	96	106	106
	Volum råga	m ³	1.30	1.46	1.62	2.22	2.42
	Volum strøken	m ³	1.07	1.19	1.32	1.80	1.95
	Vekt	kg	403	430	457	558	589
	PRIS: Sveiset krok		21 000	22 400	23 700	25 900	28 600
PRIS: Uten kroker		15 800	17 200	18 500	20 700	23 400	
Kroksats			5 200				
Skjærstål 500 HB		4 900	5 200	5 800	6 100	6 400	
Skjærstål plast		7 200	7 600	8 300	9 000	9 800	
Isriverstål		5 700	5 900	6 300	7 000	7 300	
Side beskyttelse		1 600	1 600	1 600	1 600	1 600	
Spill beskyttelse L+ / XL+		2 000	2 000	2 000	2 000	2 000	
Dekkeplate for siktvindu		700	900	900	1 000	1 000	

Euro
SMS

BoH
M24

VL SKUFFE			205	225	245	265
	Bredde	cm	204	224	245	265
	Dybde	cm	104	104	109.5	109.5
	Høyde	cm	83	83	98	98
	Volum råga	m ³	1.16	1.28	1.70	1.85
	Volum strøken	m ³	0.97	1.06	1.42	1.54
	Vekt	kg	292	317	466	499
	PRIS: Sveiset krok		15 500	16 500	18 800	21 200

Euro
SMS

VL skuffe erstatter HV og HDV skuffe

VM SKUFFE			185	205	225	245	265
	Bredde	cm	184	204	224	245	265
	Dybde	cm	104.5	104.5	104.5	109.5	109.5
	Høyde	cm	98	98	98	98	98
	Volum råga	m ³	1.45	1.60	1.70	2.00	2.20
	Volum strøken	m ³	0.95	1.10	1.20	1.45	1.60
	Vekt	kg	316	341	366	417	443
	PRIS: Sveiset krok		16 400	17 800	18 800	20 900	24 000

Euro

VM skuff erstatter HXV skuff

VS SKUFFE			200	220
	Bredde	cm	202	222
	Dybde	cm	101.5	101.5
	Høyde	cm	83	83
	Volum råga	m ³	1.13	1.25
	Volum strøken	m ³	0.95	1.04
	Vekt	kg	219	235
	PRIS: Sveiset krok		10 200	10 800

Euro
SMS
Type3

VS skuffe erstatter LV skuffe

VS+ SKUFFE			90	100	120	140	160
	Bredde	cm	88	98	118	138	158
	Dybde	cm	97	97	97	97	97
	Høyde	cm	75	75	75	75	75
	Volum råga	m ³	0.43	0.47	0.59	0.70	0.81
	Volum strøken	m ³	0.35	0.39	0.47	0.56	0.64
	Vekt	kg	118	131	157	185	211
	PRIS: Uten kroker		8 300	8 900	10 000	11 200	13 200
Kroksats			2 100		3 300		
Skjærstål 500 HB		2 200	2 500	2 900	3 300	3 700	
Skjærstål plast		3 600	4 300	4 900	5 700	6 100	
Isriverstål		2 600	2 900	3 200	3 900	4 200	
Side beskyttelse		1 600	1 600	1 600	1 600	1 600	
Spill beskyttelse S+		N/A	1 000	1 000	1 000	1 000	

NEW

BoH
M16 S/L

Fra størrelse 120 er Euro-krok mulig.
M16L-kroken anbefales på størrelse 140 og 160

Artikkelnummerliste
kroksatser se side 64

TYPE V (VOLUM) SKUFFE

Redskap	Art.nr.	Kroktyp	Pris	Redskap	Art.nr.	Kroktyp	Pris	Redskap	Art.nr.	Kroktyp	Pris
Skuffe VXL+				Tilbehør VL+				Skuffe VM			
Skuffe VXL+ 245	11255642Q	uten krok	30 100	Skjærstålsats VL+ 180	11255493Q		4 900	Skuffe VM 185	11255877Q	Euro	16 400
Skuffe VXL+ 265	11255644Q	uten krok	35 700	Skjærstålsats VL+ 200	11255494Q		5 200	Skuffe VM 205	11255880Q	Euro	17 800
Skuffe VXL+ 285	11255645Q	uten krok	45 900	Skjærstålsats VL+ 220	11255495Q		5 800	Skuffe VM 225	11255883Q	Euro	18 800
Skuffe VXL+ 305	11255646Q	uten krok	65 600	Skjærstålsats VL+ 240	11255496Q		6 100	Skuffe VM 245	11255887Q	Euro	20 900
Tilbehør VXL+				Skjærstålsats VL+ 260	11255497Q		6 400	Skuffe VM 265	11255891Q	Euro	24 000
Skjærstålsats VXL+ 245	11255659Q		7 500	Isriverstål VL+ 180	11255499Q		5 700	Skuffe VS			
Skjærstålsats VXL+ 265	11255660Q		7 900	Isriverstål VL+ 200	11255501Q		5 900	Skuffe VS 200	11255903Q	Euro	10 200
Skjærstålsats VXL+ 285	11255661Q		8 300	Isriverstål VL+ 220	11255502Q		6 300	Skuffe VS 200	11255904Q	SMS	10 200
Skjærstålsats VXL+ 305	11255662Q		8 900	Isriverstål VL+ 240	11255503Q		7 000	Skuffe VS 200	11255902Q	Typ 3	10 200
Isriverstål: SE KONFIGURATOR FOR ART.NR.				Isriverstål VL+ 260	11255504Q		7 300	Skuffe VS 220	11255443Q	Euro	10 800
Side beskyttelse VXL+ 245-265	11255643Q		2 200	Skjærstålsats plast VL+ 180	11255505Q		7 200	Skuffe VS 220	11255906Q	SMS	10 800
Side beskyttelse VXL+ 285-305	11255730Q		2 200	Skjærstålsats plast VL+ 200	11255506Q		7 600	Skuffe VS 220	11255905Q	Typ 3	10 800
Dekkeplate	11255609Q		1 000	Skjærstålsats plast VL+ 220	11255507Q		8 300	Skuffe VS+			
Spill beskyttelse L+ / XL+	11256106Q		2 000	Skjærstålsats plast VL+ 240	11255508Q		9 000	Skuffe VS+ 90	11256089Q	uten krok	8 300
Skuff VL+				Skjærstålsats plast VL+ 260	11255509Q		9 800	Skuffe VS+ 100	11256090Q	uten krok	8 900
Skuffe VL+ 180	11255581Q	uten krok	15 800	Side beskyttelse VL+ 180-260	11255517Q		1 600	Skuffe VS+ 120	11256092Q	uten krok	10 000
Skuffe VL+ 180	11255489Q	Euro	21 000	Dekkeplate VL+ 180	11255606Q		700	Skuffe VS+ 140	11256094Q	uten krok	11 200
Skuffe VL+ 180	11255488Q	SMS	21 000	Dekkeplate VL+ 200/220	11255608Q		900	Skuffe VS+ 160	11256095Q	uten krok	13 200
Skuffe VL+ 200	11255582Q	uten krok	17 200	Dekkeplate VL+ 240/260	11255609Q		1 000	Tilbehør VS+			
Skuffe VL+ 200	11255487Q	Euro	22 400	Spill beskyttelse L+ / XL+	11256106Q		2 000	Er det samme som till Skuffe GS+, se side 15			
Skuffe VL+ 200	11255486Q	SMS	22 400	Skuffe VL							
Skuffe VL+ 220	11255583Q	uten krok	18 500	Skuffe VL 205	11255872Q	Euro	15 500				
Skuffe VL+ 220	11255485Q	Euro	23 700	Skuffe VL 205	11255873Q	SMS	15 500				
Skuffe VL+ 220	11255484Q	SMS	23 700	Skuffe VL 225	11255874Q	Euro	16 500				
Skuffe VL+ 240	11255584Q	uten krok	20 700	Skuffe VL 225	11255876Q	SMS	16 500				
Skuffe VL+ 240	11255483Q	Euro	25 900	Skuffe VL 245	11255894Q	Euro	18 800				
Skuffe VL+ 240	11255482Q	SMS	25 900	Skuffe VL 245	11255895Q	SMS	18 800				
Skuffe VL+ 260	11255580Q	uten krok	23 400	Skuffe VL 265	11255896Q	Euro	21 200				
Skuffe VL+ 260	11255481Q	Euro	28 600	Skuffe VL 265	11255897Q	SMS	21 200				
Skuffe VL+ 260	11255480Q	SMS	28 600								

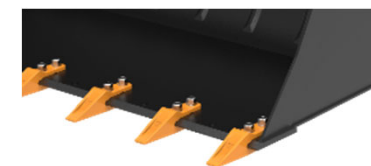
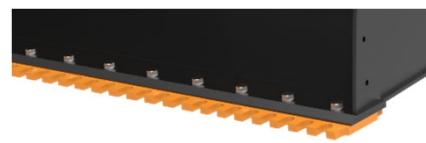

SKJÆRSTÅL 500 HB		
GS+		
Skjærstål 500 HB 90	11255524Q	2 200
Skjærstål 500 HB 100	11255525Q	2 500
Skjærstål 500 HB 120	11255527Q	2 900
Skjærstål 500 HB 140	11255528Q	3 300
Skjærstål 500 HB 160	11255529Q	3 700
SM+ / GM+ / GL+ / GXL+ / VL+		
Skjærstål 500 HB 160	11255535Q	4 400
Skjærstål 500 HB 180	11255493Q	4 900
Skjærstål 500 HB 200	11255494Q	5 200
Skjærstål 500 HB 220	11255495Q	5 800
Skjærstål 500 HB 240	11255496Q	6 100
Skjærstål 500 HB 260	11255497Q	6 400
VXL+		
Skjærstål 500 HB 245	11255659Q	7 500
Skjærstål 500 HB 265	11255660Q	7 900
Skjærstål 500 HB 285	11255661Q	8 300
Skjærstål 500 HB 305	11255662Q	8 900
SL+ / SXL+		
Skjærstål 500 HB 220	11255782Q	7 000
Skjærstål 500 HB 240	11255783Q	7 300
Skjærstål 500 HB 265	11255784Q	7 800
Skjærstål 500 HB 275	11255785Q	8 100
Skjærstål 500 HB 295	11255786Q	8 700

SKJÆRSTÅL PLAST		
GS+		
Skjærstål plast 90	11255547Q	3 600
Skjærstål plast 100	11255546Q	4 300
Skjærstål plast 120	11255545Q	4 900
Skjærstål plast 140	11255544Q	5 700
Skjærstål plast 160	11255543Q	6 100
SM+ / GM+ / GL+ / GXL+ / VL+		
Skjærstål plast 160	11255537Q	6 400
Skjærstål plast 180	11255505Q	7 200
Skjærstål plast 200	11255506Q	7 600
Skjærstål plast 220	11255507Q	8 300
Skjærstål plast 240	11255508Q	9 000
Skjærstål plast 260	11255509Q	9 800
VXL+		
Skjærstål plast 245	11255665Q	11 100
Skjærstål plast 265	11255667Q	11 600
Skjærstål plast 285	11255669Q	12 500
Skjærstål plast 305	11255671Q	13 000

ISRIVERSTÅL		
GS+		
Isriverstål 90	11255538Q	2 600
Isriverstål 100	11255539Q	2 900
Isriverstål 120	11255540Q	3 200
Isriverstål 140	11255541Q	3 900
Isriverstål 160	11255542Q	4 200
SM+ / GM+ / GL+ / GXL+ / VL+		
Isriverstål 160	11255536Q	5 100
Isriverstål 180	11255499Q	5 700
Isriverstål 200	11255501Q	5 900
Isriverstål 220	11255502Q	6 300
Isriverstål 240	11255503Q	7 000
Isriverstål 260	11255504Q	7 300
VXL+		
Isriverstål 245	11255664Q	8 100
Isriverstål 265	11255666Q	8 600
Isriverstål 285	11255668Q	9 100
Isriverstål 305	11255670Q	9 600

PÅSKRUBARE TENNER		
SM+ / SL+ / SXL+		
Tenner SM+ 160-180 6 st 18 mm	11255726Q	3 100
Tenner SM+ 200-220 7 st 18 mm	11255727Q	3 300
Tenner SM+ 240 8 st 18 mm	11255728Q	3 900
Tenner SM+ 260 9 st 18 mm	11255729Q	4 300
Tenner SL+ 220 7 st 20 mm	11255414Q	4 300
Tenner SL+ 240 8 st 20 mm	11255417Q	4 800
Tenner SL+ 265 9 st 20 mm	11255418Q	5 400
Tenner SXL+ 275 9 st 25 mm	11255419Q	6 300
Tenner SXL+ 295 10 st 25 mm	11255420Q	7 100



SIDESKYDD		
Side beskyttelse GXL+/GL+/GM+/GS+	11255516Q	1 600
Side beskyttelse VL+	11255517Q	1 600
Side beskyttelse VXL+ 245-265	11255643Q	2 200
Side beskyttelse VXL+ 285-305	11255730Q	2 200

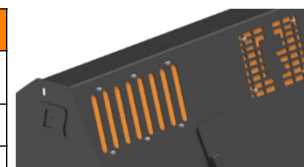

DEKKEPLATE FOR SIKTVINDU		
VL+ / VXL+		
Dekkeplate VL+ 180	11255606Q	700
Dekkeplate VL+ 200/220	11255608Q	900
Dekkeplate VL+/VXL+ 240-305	11255609Q	1 000



SPILL BESKYTTELSE

Sørger for at du ikke søler materiale på redskapsfeste.

NEW

SPILL BESKYTTELSE S

S



GS+, VS+ Buckets

A. Bredde	mm	900
B. Dybde	mm	241
C. Høyde	mm	139

11256175Q	PRIS:	1 000
-----------	-------	-------

SPILL BESKYTTELSE M

M



GM+, SM+. Gjødselgrep, Multibenne, Silograb XL

A. Bredde	mm	1300
B. Dybde	mm	241
C. Høyde	mm	139

11256105Q	PRIS:	1 800
-----------	-------	-------

SPILL BESKYTTELSE L OG XL

L & XL

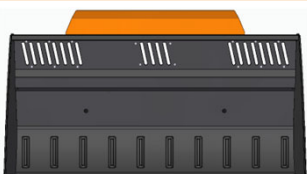

GL+, GXL+, VL+, VXL+, SL+, SXL+ Skuffer

A. Bredde	mm	1550
B. Dybde	mm	296
C. Høyde	mm	212

11256106Q	PRIS:	2 000
-----------	-------	-------

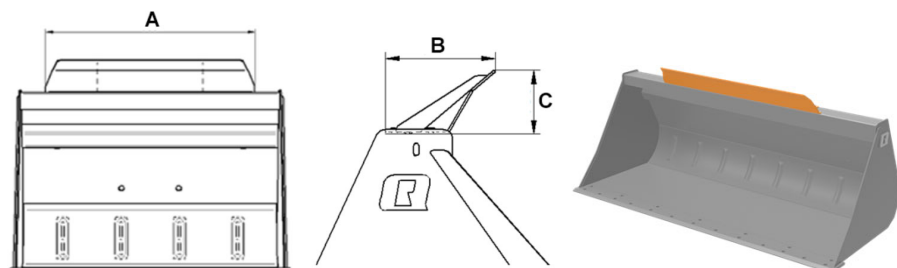

TANN OG GREPS BESKYTTELSE

Tann- og greps beskyttelse er designet for redskap som stengrep, storballespyd og skuffer med tenner.

Det finnes to sett som dekker alle bredder av redskapene.

Dette øker sikkerhet ved transport på offentlig vei.

NEW

TANN OG GREPS BESKYTTELSE 120-220 OG 220-295

120 - 220

Justerbar bredde	cm	120-220
Vekt	kg	12

11256300Q	PRIS:	600
-----------	-------	-----

220 - 295

Justerbar bredde	cm	220-295
Vekt	kg	17

11256329Q	PRIS:	800
-----------	-------	-----

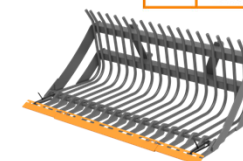
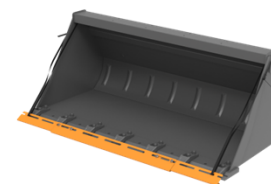
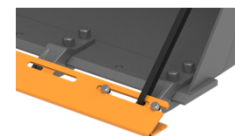

TETTNINGSPLUGG FOR SKUFFER

NEW

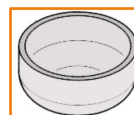

Beskrivelse	Dia mm	Antall	Artikkelnr.	Pris
Tettningsplugg S+	19.4	15	11256494Q	160
Tettningsplugg M+ - XL+	23.4	18	11256497Q	200
Tettningsplugg M+ - XL+		30	11256498Q	260

For kunder som håndterer løs materiale som f.eks korn.
+ Skuffer har hull for montering av ekstra skjærstål.
Disse pluggene monteres i hullene for å unngå søl.

KOMPAKT SKUFFER OG UTILITY SKUFFER

Quicke

CS OG CM SKUFFE			120 CS	135 CS	150 CM
	Bredde	cm	122	136	150
	Dybde	cm	60	60	60
	Høyde	cm	50	50	55
	Volum råga	m ³	0.20	0.23	0.29
	Volum strøken	m ³	0.15	0.17	0.22
	Vekt	kg	69	76	91
	PRIS: Sveiset krok			4 800	5 200

Euro

MULTIFUNKSJONSSKUFFE UTILITY			160 MPU	185 MPU	210 MPU
	Bredde	cm	162.1	187.1	212.1
	Dybde	cm	54	54	54
	Høyde	cm	60	60	60
	Volum råga	m ³	0.40	0.47	0.53
	Volum strøken	m ³	0.32	0.37	0.42
	Vekt	kg	264	291	318
	PRIS: Sveiset krok			32 200	35 900

Euro

CL SKUFFE			130	150	170
	Bredde	cm	132	152	172
	Dybde	cm	66.5	66.5	66.5
	Høyde	cm	59	59	59
	Volum råga	m ³	0.34	0.39	0.44
	Volum strøken	m ³	0.28	0.32	0.36
	Vekt	kg	99	109	120
	PRIS: Sveiset krok			6 300	6 900

Euro

MULTIGRAB C & CS			CS 120	C 120	C 140	C 170	
	Bredde	cm	124	124	139	172	
	Dybde	cm	51.6	59.8	59.8	59.8	
	Høyde	cm	64	74	74	74	
	Volum	m ³	0.22	0.3	0.34	0.42	
	Vekt	kg	90	133	141	161	
	PRIS: Sveiset krok			13 000	15 500	16 500	17 500
	Sideplater			400	500		
Grep stål			600			700	

Euro
Skid
steer

NEW

MULTIFUNKSJONSSKUFFE KOMPAKT			120 MPC	140 MPC	170 MPC	180 MPC
	Bredde	cm	122	137.1	167.1	182.1
	Dybde	cm	40.8	40.8	40.8	40.8
	Høyde	cm	44	44	44	44
	Volum råga	m ³	0.19	0.21	0.25	0.28
	Volum strøken	m ³	0.14	0.16	0.19	0.21
	Vekt	kg	132	155	177	187
	PRIS: Sveiset krok			14 800	16 700	17 900

Pin-on
(120)
Euro
(140-
180)

Tilbehør:

Sideplater



Grep stål

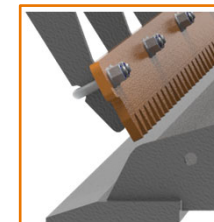

Sideplater + Grep stål



KOMPAKT SKUFFER OG UTILITY SKUFFER



Redskap	Art.nr.	Kroktyp	Pris
Skuffe CS OCH CM			
Skuffe 120 CS	11256275Q	Euro	4 800
Skuffe 135 CS	11256279Q	Euro	5 200
Skuffe 150 CM	11256280Q	Euro	6 000
Skuffe CL			
Skuffe 130 CL	11254828Q	Euro	6 300
Skuffe 150 CL	11254829Q	Euro	6 900
Skuffe 170 CL	11254830Q	Euro	7 300
Multifunksjonsskuffe Kompakt			
Multifunksjonsskuff 120 MPC	11255404Q	Pin-on	14 800
Multifunksjonsskuff 140 MPC	11255518Q	Euro	16 700
Multifunksjonsskuff 170 MPC	11255520Q	Euro	17 900
Multifunksjonsskuff 180 MPC	11255519Q	Euro	19 800
Multifunksjonsskuffe Utility			
Multifunksjonsskuffe 160MPU	11252118Q	Euro	32 200
Multifunksjonsskuffe 185MPU	11252128Q	Euro	35 900
Multifunksjonsskuffe 210MPU	11252138Q	Euro	40 900
Multigrab C & CS			
Multigrab CS 120	11256338Q	Euro	13 000
Multigrab CS 120	11256399Q	Skidsteer	13 000
Multigrab C 120	11256286Q	Euro	15 500
Multigrab C 120	11256287Q	Skidsteer	15 500
Multigrab C 140	11256288Q	Euro	16 500
Multigrab C 140	11256289Q	Skidsteer	16 500
Multigrab C 170	11256313Q	Euro	17 500
Tilbehør Multigrab C & CS			
Sideplater Multigrab C	11256284Q		500
Grep stål C 120-140	11256285Q		600
Grep stål C 170	11256314Q		700
Grep stål CS 170	11256349Q		600
Sideplater Multigrab CS	11256350Q		400

SPESIALSKUFFER

Quicke

MULTIFUNKSJONSSKUFFE			160 MP	185 MP	210 MP	160 MPT	185 MPT	210 MPT
	Bredde	cm	161.6	186.6	211.6	161.6	186.6	211.6
	Dybde	cm	67	67	67	67	67	67
	Høyde	cm	67.5	67.5	67.5	67.5	67.5	67.5
	Volum råga	m ³	0.48	0.56	0.66	0.48	0.56	0.66
	Volum strøken	m ³	0.38	0.44	0.50	0.38	0.44	0.50
	Vekt	kg	267	401	434	373	407	441
	PRIS: Sveiset krok		35 400	37 800	40 300	36 700	39 500	41 800

Euro

MP er uten tenner på skjærstålet
MPT er med tenner på skjærstålet

KLAFFVINGESKUFFE SC230 M+			230 M+	
	Bredde	cm	230	
	Bredde med utfelte klaffer	cm	392	
	Dybde	cm	109	
	Høyde	cm	98	
	Volum råga	m ³	1.41	
	Volum strøken	m ³	1.14	
	Vekt	kg	660	
PRIS: Uten krok / slanger		61 200		
Kroksats		3 300		
Plogvinge venstre eller høyre		9 200		
Skjærstål 500 HB		5 800		
Isriverstål		9 200		
Elventilsats for Quicke lastere		5 000		
Elventilsats universal		2 800		

NEW



BoH
M16 L

Tilbehør:
Plogvinge



HØYTIPPENDE SKUFFE			160 XH	180 XH	200 XH	220 XH	240 XH	260 XH
	Bredde	cm	160	181	201	221	241	261
	Dybde	cm	117.3	117.3	117.3	117.3	117.3	117.3
	Høyde	cm	104.5	104.5	104.5	104.5	104.5	104.5
	Volum råga	m ³	1.40	1.51	1.75	1.96	2.18	2.40
	Volum strøken	m ³	1.20	1.37	1.52	1.64	1.86	2.08
	Vekt	kg	481	514	566	600	635	669
	PRIS: Sveiset krok***		N/A	N/A	44 200	46 200	48 400	50 400
PRIS: Uten krok/slanger		39 000	40 300	41 200	43 200	45 400	47 400	
Kroksats		2 100 / 3 800						
Slanger Quickelastere		900						

Euro



BoH
40x80

*** Versjonen med sveiset krok leveres komplett med slanger for tilkobling til Quicke-lastere

PREISJONS SKUFFE			200 PS	200 PC	250 PS	250 PC
	Bredde	cm	114.5	54.5	115	86.5
	Dybde	cm	198.5	198.5	249	249
	Høyde	cm	61.5	61.5	76	76
	Volum råga	m ³	0.93	0.87	1.69	1.54
	Volum strøken	m ³	0.87	0.71	1.55	1.40
	Vekt	kg	302	271	577	566
	PRIS: Sveiset krok		19 600	21 200	28 000	29 400

Euro
SMS
Store
BM
(250)

PS: Lik skuffe bredde foran og bak
PC: Kon i front

Artikkelnummerliste
kroksatser se side 64

Redskap	Art.nr.	Kroktyp	Pris
Multifunksjonsskuffe MP/MPT			
Multifunksjonsskuffe 160MP	11252148Q	Euro	35 400
Multifunksjonsskuffe 160MPT	11252448Q	Euro	37 800
Multifunksjonsskuffe 185MP	11252158Q	Euro	40 300
Multifunksjonsskuffe 185MPT	11252458Q	Euro	36 700
Multifunksjonsskuffe 210MP	11252168Q	Euro	39 500
Multifunksjonsskuffe 210MPT	11252468Q	Euro	41 800
Høytippende skuffe			
Høytippende skuffe 160XH	11256319Q	uten kroker	39 000
Høytippende skuffe 180XH	11253942Q	uten kroker	40 300
Høytippende skuffe 200XH	11252658Q	Euro	44 200
Høytippende skuffe 200XH	11252650Q	uten kroker	41 200
Høytippende skuffe 220XH	11252668Q	Euro	46 200
Høytippende skuffe 220XH	11252660Q	uten kroker	43 200
Høytippende skuffe 240XH	11252678Q	Euro	48 400
Høytippende skuffe 220XH	11252660Q	uten kroker	43 200
Høytippende skuffe 240XH	11252678Q	Euro	48 400
Høytippende skuffe 240XH	11252670Q	uten kroker	45 400
Høytippende skuffe 260XH	11252688Q	Euro	50 400
Høytippende skuffe 260XH	11252680Q	uten kroker	47 400
Tilbehør Høytippende skuffe			
Slangsats för anslutning till Quicke frontlastare	60016634		900

Redskap	Art.nr.	Kroktyp	Pris
Klaffvingesuffe SC M+			
Klaffvingesuffe SC230 M+ BOH M16	11256025Q	uten kroker	61 200
Tilbehør Klaffvingesuffe SC M+			
Skjærstål (kun skuffe)	11255495Q		5 800
Isriverstål (skuffe og klaffer)	11256009Q		9 200
Skjærstål i plast (skuffe og klaffer)	11256014Q		12 100
Plogvinge høyre side	11256078Q		9 200
Plogvinge venstre side	11256081Q		9 200
Elventilsats frontlaster QCS QM-command	60073414		5 000
Elventilsats frontlaster QCS QE-com. og slangasats	60073435		3 100
Elventilsats eldre frontlaster	60028679		6 300
Elventilsats universal 12 volt	60002069		2 800
Slangsats (4 slangar) för anslutning till Quicke frontlastare	60013337		900
Tilbehør Eldre Klaffvingesuffe (230 SC)			
Skjærstål (Skuff, ikke klaffer)	60000485		5 800
Isriverstål (Skuff & klaffer)	11262520		8 600
Presisjonssuffe			
Presisjonssuffe 200 PS	11253138Q	Euro	19 600
Presisjonssuffe 200 PS	11253135Q	SMS	19 600
Presisjonssuffe 200 PC	11253148Q	Euro	21 200
Presisjonssuffe 200 PC	11253145Q	SMS	21 200
Presisjonssuffe 250 PS	11253169Q	Store BM	28 000
Presisjonssuffe 250 PC	11253159Q	Store BM	29 400

SPESIALSKUFFER

Quicke

PLANERINGSSKUFFE			180	200	220	240
	Bredde	cm	184	204	224	244
	Dybde	cm	109	109	109	109
	Høyde	cm	48	48	48	48
	Volum råga	m ³	0.62	0.70	0.78	0.86
	Volum strøken	m ³	0.44	0.49	0.52	0.58
	Vekt	Kg	282	308	333	402
	Skjærstål (BxT)	mm	150X20	150X20	150X20	200X20
PRIS: Sveiset krok			16 800	17 700	18 900	22 200

Euro
SMS

PLANERINGSSKUFFE S			100	120	140	160
	Bredde	cm	98	118	138	158
	Dybde	cm	83	83	83	83
	Høyde	cm	40	40	40	40
	Volum råga	m ³	0.220	0.275	0.33	0.39
	Volum strøken	m ³	0.15	0.19	0.22	0.25
	Vekt	kg	110	125	160	177
	Skjærstål (BxT)	mm	100X14	100X14	100X14	100X14
PRIS: Sveiset krok			11 400	11 800	12 100	12 600
Snøkrage			2 900	3 100	3 300	3 600

Euro *120-160
SMS
Avant
Kramer Kompact

PLANERINGSSKUFFE XL			220 XL	240 XL	260 XL	280 XL	300 XL
	Bredde	cm	220.6	242.6	262.5	282.8	302.4
	Dybde	cm	118	118	137.5	137.5	152.5
	Høyde	cm	54.5	54.5	54.5	54.5	54.5
	Volum råga	m ³	1.05	1.15	1.56	1.69	1.97
	Volum strøken	m ³	0.79	0.87	1.14	1.23	1.97
	Vekt	kg	646	683	900	945	1151
	Skjærstål (BxT)	mm	200X20	200X20	200X25	200X25	250X30
PRIS: Sveiset krok			33 000	34 400	40 100	41 500	47 400
Spill beskyttelse			3 100	3 100	3 100	3 100	3 100
Lastsikring kroker			400	400	400	400	400
Snøkrage			7 100	7 400	8 300	8 600	9 200

Store
BM

Tilbehør:
Snøkrage



Tilbehør:
Snøkrage
Spill beskyttelse
Lastsikring kroker

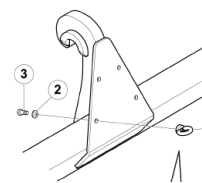
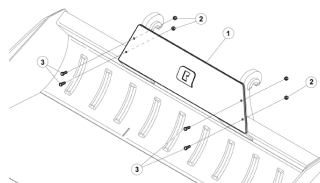

SPESIALSKUFFER



Redskap	Art.nr.	Kroktyp	Pris
Planeringsskuffe			
Planeringsskuffe 180	11252408Q	Euro	16 800
Planeringsskuffe 180	11252405Q	SMS	16 800
Planeringsskuffe 200	11252418Q	Euro	17 700
Planeringsskuffe 200	11252415Q	SMS	17 700
Planeringsskuffe 220	11251528Q	Euro	18 900
Planeringsskuffe 220	11251525Q	SMS	18 900
Planeringsskuffe 240	11251738Q	Euro	22 200
Planeringsskuffe 240	11251735Q	SMS	22 200
Planeringsskuffe XL			
Planeringsskuffe 220 XL	11254993Q	Store BM	33 000
Planeringsskuffe 240 XL	11254994Q	Store BM	34 400
Planeringsskuffe 260 XL	11254995Q	Store BM	40 100
Planeringsskuffe 280 XL	11254996Q	Store BM	41 500
Planeringsskuffe 300 XL	11254997Q	Store BM	47 400
Tilbehør Planeringsskuffe XL			
Spill beskyttelse	60026027		3 100
Lastsikring kroker	60034648		400
Snøkrage 220 XL	11255698Q		7 100
Snøkrage 240 XL	11255699Q		7 400
Snøkrage 260 XL	11255700Q		8 300
Snøkrage 280 XL	11255701Q		8 600
Snøkrage 300 XL	11255702Q		9 200

Redskap	Art.nr.	Kroktyp	Pris
Planeringsskuffe S			
Planeringsskuffe S 100	11255826Q	Avant	11 400
Planeringsskuffe S 100	11255827Q	Kramer Compact	11 400
Planeringsskuffe S 100	11255828Q	SMS	11 400
Planeringsskuffe S 120	11255829Q	Avant	11 800
Planeringsskuffe S 120	11255830Q	Euro	11 800
Planeringsskuffe S 120	11255831Q	Kramer Compact	11 800
Planeringsskuffe S 120	11255832Q	SMS	11 800
Planeringsskuffe S 140	11255833Q	Avant	12 100
Planeringsskuffe S 140	11255834Q	Euro	12 100
Planeringsskuffe S 140	11255835Q	Kramer Compact	12 100
Planeringsskuffe S 140	11255836Q	SMS	12 100
Planeringsskuffe S 160	11255837Q	Avant	12 600
Planeringsskuffe S 160	11255838Q	Euro	12 600
Planeringsskuffe S 160	11255839Q	Kramer Compact	12 600
Planeringsskuffe S 160	11255840Q	SMS	12 600
Tilbehør Planeringsskuffe S			
Snøkrage 100 S	11255855Q		2 900
Snøkrage 120 S	11255875Q		3 100
Snøkrage 140 S	11255884Q		3 300
Snøkrage 160 S	11255890Q		3 600

POWERGRAB M+			165 ¹	180	200	220	240 ³	260 ³	Åpning
	Bredde	cm	165	180	200	220	240	260	1620mm
	Dybde	cm	116	116	116	82	116	116	
	Volum	m ³	1.0	1.1	1.2	1.3	1.4	1.5	
	Vekt	kg	558	588	617	660	759	780	
PRIS: Sveiset krok			N/A	N/A	51 800	56 300	61 000	N/A	
PRIS: Utan krok / slanger			42 000	49 000	50 300	54 800	59 500	62 300	
Kroksats			2 600						
Skjærstål 500 HB			4 700	4 900	5 200	5 800	6 100	6 400	
Slanger Quickelastare			900						
Trykkbegrenser			2 700						
Lasteventil			4 200						

Unik mulighet for 2-delt gripedel

PowerGrab M+ i bredde 240 og 260 kan fås med 2-delt gripedel. Det betyr at høyre og venstre side av gripedelen kan bevege seg uavhengig av hverandre. Dette er en stor fordel ved uttak av silo eller håndtering av annen løs materiale. Prispåslag for 2-delt gripedel er 2000 kr

³ Prispåslag for 2-delt gripedel er 2000 kr

NEW



Over 210 bar
Trykkbegrenser
nødvendig

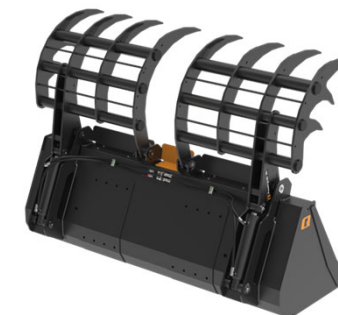

Lasteventil**

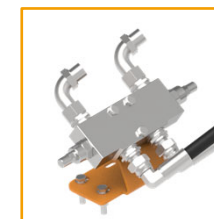

**Viktig. Lasteventilen inneholder ikke trykkbegrenser.

¹ Powergrab 165 med Euro feste passer ikke til Q-serie lastere med Euro eller Euro/SMS redskapsramme.

² Powergrab med sveisede kroker er inkl. slanger som passer til Quicke frontlaster.

Benytt **M16L Euro 16^o** til Quicke frontlaster

POWERGRAB L+			200	220	240	260
	Bredde	cm	200	220	240	260
	Dybde	cm	100	100	100	100
	Volum	m ³	1.60	1.75	1.95	2.10
	Max åpning	cm	199	199	199	199
Skjærstål (BxT)	mm	200X20	200X20	200X20	200X20	
Vekt	kg	917	957	1060	1097	
PRIS: Utan krok / slanger			58 000	62 000	66 000	70 000
Kroksats			5 200			
Skjærstål 500 HB			6 600	6 800	7 000	7 200
Slanger Quickelastare			900			
Trykkbegrenser			2 900			



over 230 bar
Trykkbegrenser
nødvendig

BoH
M24

POWERGRAB XL+			220	240	260	280
	Bredde	cm	240	260	280	295
	Dybde	cm	116	116	116	116
	Volum	m ³	2.45	2.65	2.85	3.0
	Max åpning	cm	213	213	213	213
Skjærstål (BxT)	mm	200X20	200X20	200X20	200X20	
Vekt	kg	1336	1380	1425	1458	
PRIS: Uten krok / slanger			85 500	91 500	100 500	103 000
Kroksats			5 200			
Skjærstål 500 HB			7 300	7 500	7 600	8 700
Slanger Quickelastare			900			







over 230 bar
Trykkbegrenser
nødvendig

BoH
M24

Redskap	Art.nr.	Kroktyp	Pris
Powergrab M+			
Powergrab M+ 165	11256261Q	uten krokar	42 000
Powergrab M+ 180	11256262Q	uten krokar	49 000
Powergrab M+ 200	11256263Q	uten krokar	50 300
Powergrab M+ 200	11256340Q	Euro	51 800
Powergrab M+ 220	11256264Q	uten krokar	54 800
Powergrab M+ 220	11256341Q	Euro	56 300
Powergrab M+ 240	11256265Q	uten krokar	59 500
Powergrab M+ 240	11256343Q	Euro	61 000
Powergrab M+ 240 Dual	11256267Q	uten krokar	61 500
Powergrab M+ 260	11256266Q	uten krokar	62 300
Powergrab M+ 260 Dual	11256268Q	uten krokar	64 300
Tilbehør Powergrab M+			
Skjærstålsats Powergrab 165	11256397Q		4 700
Skjærstålsats Powergrab 180	11255493Q		4 900
Skjærstålsats Powergrab 200	11255494Q		5 200
Skjærstålsats Powergrab 220	11255495Q		5 800
Skjærstålsats Powergrab 240	11255496Q		6 100
Skjærstålsats Powergrab 260	11255497Q		6 400
Tryckbegrenser	60002029		2 800
Lasteventil	11256743Q		4 200
Slangesats for tilkobling til Quicke frontlaster	60016632		900
Slangesats. Lengde 2250 mm med Tema 3/4"	60002021		2 700

Redskap	Art.nr.	Kroktyp	Pris
Powergrab L+			
Powergrab L+ 200	11256198Q	uten kroker	58 000
Powergrab L+ 220	11256201Q	uten kroker	62 000
Powergrab L+ 240	11256063Q	uten kroker	66 000
Powergrab L+ 260	11256202Q	uten kroker	70 000
Tilbehør Powergrab L+			
Skjærstålsats Powergrab L+ 200	11256139Q		6 600
Skjærstålsats Powergrab L+ 220	11256222Q		6 800
Skjærstålsats Powergrab L+ 240	11256221Q		7 000
Skjærstålsats Powergrab L+ 260	11256220Q		7 200
Trykkbegrenser	60071811		2 800
Slangesats for tilkobling til Quicke frontlaster	60016632		900
Slangesats. Lengde 2250mm med Tema 3/4"	10377059		2 700
Powergrab XL+			
Powergrab XL+ 240	11256065Q	uten kroker	85 500
Powergrab XL+ 260	11256203Q	uten kroker	91 500
Powergrab XL+ 280	11256204Q	uten kroker	100 500
Powergrab XL+ 295	11256205Q	uten kroker	103 000
Tilbehør Powergrab XL+			
Skjærstålsats Powergrab XL+ 240	11255783Q		7 300
Skjærstålsats Powergrab XL+ 260	11256223Q		7 500
Skjærstålsats Powergrab XL+ 280	11256224Q		7 600
Skjærstålsats Powergrab XL+ 295	11255786Q		8 700
Trykkbegrenser	60071811		2 800
Slangesats. Lengde 2250mm med Tema 3/4"	10377059		2 700

SILOCUT M+			125	150	175	200	225	150	175	200	225	
			F	F	F	F	F	P	P	P	P	
	Bredde	cm	125	150	175	200	225	150	175	200	225	
	Max trykk	bar	210	210	210	250	250	210	210	250	250	
	Total høyde åpen	cm	133	133	133	133	133	133	133	133	133	
	Max åpningshøyde	cm	77	77	77	77	77	77	77	77	77	
	Total høyde	cm	95	95	95	95	95	95	95	95	95	
	Dybde	cm	67	67	67	67	67	67	67	67	67	
	Antall tinner		8	10	12	14	16	10	12	14	16	
	Tinnelengde	mm	820	820	820	820	820	820	820	820	820	820
	Antall sylindre		2	2	2	3	3	2	2	3	3	
	Sylinderstørrelse	mm	90/40	100/50	110/50	110/5 (x2) 90/40 (x1)	100/50	100/50	110/50	110/5 (x2) 90/40 (x1)	100/50	100/50
Volum	m ³	0.8	0.95	1.1	1.25	1.4	0.95	1.1	1.25	1.4		
Vekt	Kg	476	528	609	751	790	507	595	720	759		
PRIS: Uten krok / slange			41 400	44 700	50 200	67 600	72 200	44 700	50 200	67 600	72 200	
Kroksats			2 100 / 3 800				2 100 / 3 800					
Dekkplate for ryggen	1		1 500	1 700	1 900	2 100	2 600	1 700	1 900	2 100	2 600	
Slanger Quickelastere			900				900					
Trykkbegrenser			2 800				2 800					
Lasteventil/Trykkbegrenser			3 100				3 100					
Tinnetype			F – Smidde, skrudde tinner				P – Utskjærte tinner					
 			 F				 P					

77cm

Tilbehør:

Dekkplate

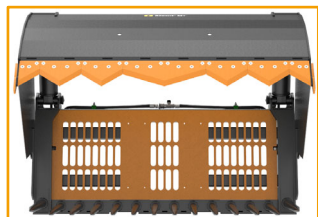

Trykkbegrenser



Artikkelnummerliste
kroksatser se side 64

Redskap	Artikelnr.	Kroktyp	Pris
Silocut M+ F smidde, skrudde tenner			
Silocut M+ F 125	11254226Q	Euro	44 400
Silocut M+ F 125	11254224Q	utan kroker	41 400
Silocut M+ F 150	11254228Q	utan kroker	44 700
Silocut M+ F 175	11254231Q	utan kroker	50 200
Silocut M+ F 200	11254234Q	utan kroker	67 600
Silocut M+ F 225	11254237Q	utan kroker	72 200
Silocut M+ P utskjærte tenner			
Silocut M+ P 150	11255962Q	utan kroker	44 700
Silocut M+ P 175	11255961Q	utan kroker	50 200
Silocut M+ P 200	11255960Q	utan kroker	67 600
Silocut M+ P 225	11255844Q	utan kroker	72 200
Tilbehør Silocut M+			
Dekkplate for ryggen 125	11255279Q		1 500
Dekkplate for ryggen 150	11255280Q		1 700
Dekkplate for ryggen 175	11255281Q		1 900
Dekkplate for ryggen 200	11255282Q		2 100
Dekkplate for ryggen 225	11255283Q		2 600
Trykkbegrenser	60002029		2 800
Lasteventil/Trykkbegrenser	60040820		3 100
Slangsets för anslutning till Quicke frontlastare	60002004		900
Slangsets. Längd 2250 mm med Tema 3/4"	60002021		2 700

SILOCUT L+

NEW



126 cm

Bredde	cm	175	200	225	250
Total høyde åpen	cm	184	184	184	184
Max åpningshøyde	cm	126	126	126	126
Dybde	cm	83	83	83	83
Antall tinner		14	16	18	20
Tinnelengde	mm	820	820	820	820
Antall sylindre		2	2	2	2
Sylinderstørrelse	mm	110/50	125/60	125/60	125/60
Skjærstål (BxT)	mm	-	-	-	-
Volum	m ³	1.4	1.6	1.8	2.0
Vekt uten kroker	kg	924	994	1053	1122

PRIS: Uten krok / slange **79800** **86700** **92400** **98300**

Kroksats 2 100 / 3 800

Hydraulisk avskyver 1 13900 16200 18500 20800

Plast og nett holder* 2 5900

Dekkplate for ryggen 3 1500 1900 1900 1900

Sekvensventil for avskyver 5900
 Slangesats avskyver 900
 Sekvensventil Plast og nett holder 5900
 Slangesats Plast og nett holder 900
 Trykkbegrenser 2800

Tinnetype

F – Smidde, skrudd tinner

P – Utskjærte tinner

B = Skuffeversjon



over 230 bar
Trykkbegrenser
nødvendig

BoH
80x80



F



P



B

Tilbehør:

(1) Avskyver, hydraulisk

(2) Plast og nett holder

(3) Dekkplate

Sekvensventil

Plast og nett holder

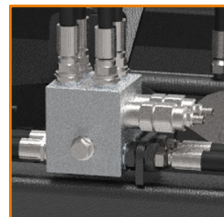

*4:e funksjon er nødvendig hvis sekvensventil ikke er installert.

Redskap	Artikelnr.	Kroktyp	Pris
Silocut L+			
Silocut L+ 175 smidde, skrudde tenner	11256073Q		79 800
Silocut L+ 200 smidde, skrudde tenner	11256016Q		86 700
Silocut L+ 225 smidde, skrudde tenner	11256072Q		92 400
Silocut L+ 250 smidde, skrudde tenner	11256026Q		98 300
Silocut L+ 175 utskjærte tenner	11256071Q		78 600
Silocut L+ 200 utskjærte tenner	11256070Q		85 500
Silocut L+ 225 utskjærte tenner	11256069Q		91 300
Silocut L+ 250 utskjærte tenner	11256030Q		97 100
Silocut L+ 175 skuffe	11256086Q		80 900
Silocut L+ 200 skuffe	11256024Q		87 800
Silocut L+ 225 skuffe	11256087Q		93 700
Silocut L+ 250 skuffe	11256088Q		99 400
Tilbehør Silocut L+			
Plast og nett holder	11256067Q		5 900
Avskyver L+ 175	11256029Q		13 900
Avskyver L+ 200	11256059Q		16 200
Avskyver L+ 225	11256041Q		18 500
Avskyver L+ 250	11256060Q		20 800
Dekkplate for ryggen L+ 175	11256031Q		1 500
Dekkplate for ryggen L+ 200-250	11256032Q		1 900
Sekvensventil Plast og nett holder	60071029		5 900
Slangesats Plast og nett holder	60071881		900
Sekvensventil Avskyver	60071030		5 900
Slangesats Avskyver	60071982		900
Trykkbegrenser	60071811		2 800
Slangesats till Quicke frontlastare. Längd 1250 mm.	10377059		2 700
Slangesats. Längd 2250 mm med Tema 3/4"	10377059		2 700

SILOCUT XL+			225 F	250 F	225 P	250 P	225 B	250 B
	Bredde	cm	225	250	225	250	225	250
	Total høyde åpen	cm	192	192	192	192	187	192
	Max åpningshøyde	cm	125	125	128	128	125	125
	Totalhøyde	cm	139	139	139	139	139	139
	Dybde	cm	86	86	84	84	94	94
	Antall tinner		15	17	18	20	-	-
	Tinne lengde	mm	985	985	947	947	-	-
	Antall sylindre		2	2	2	2	2	2
	Sylinderstørrelse	mm	125/60	125/60	125/60	125/60	125/60	125/60
	Skjærstål (BxT)	mm	-	-	-	-	220X20	220X20
Volum	m ³	2.4	2.7	2.4	2.7	2.4	2.7	
Vekt	kg	1381	1498	1469	1615	1498	1632	
PRIS: Uten krok / slanger			108 500	117 100	107 300	115 900	117 100	129 800
Kroksats			5 200		5 200		5 200	
Hydraulisk avskyver	1	23 100	24 500	23 100	24 500	Ikke tilgjengelig		
Plast og nett holder*	2	5 900		5 900		5 900		
Sekvensventil Avskyver			5 900		5 900		Ikke tilgjengelig	
Slangesats Avskyver			900		900		Ikke tilgjengelig	
Sekvensventil Plast og nett holder			5 900		5 900		5 900	
Slangesats Plast og nett holder			900		900		900	
Trykkbegrenser			2 800		2 800		2 800	
Tinnetype			F – Smidde, skrudd tinner		P – Utskjærte tinner		B = Skuffeversjon	



125/128 cm

Tilbehør:

(1) Hydraulisk avskyver



(2) Plast og nett holder



Sekvensventil

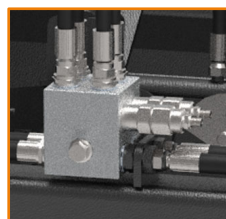

Plast og nett holder

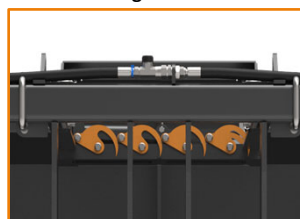

Silocut XL+ B



Silocut XL+ P

*4:e funksjon er nødvendig hvis sekvensventil ikke er installert.

Artikkelnummerliste
kroksatser se side 64

Redskap	Art.nr.	Kroktyp	Pris
Silocut XL			
Silocut XL+ 225 smidde, skrudde tenner	11256099Q	uten kroker	108 500
Silocut XL+ 250 smidde, skrudde tenner	11256102Q	uten kroker	117 100
Silocut XL+ 225 utskjærte tenner	11255267Q	uten kroker	107 300
Silocut XL+ 250 utskjærte tenner	11256103Q	uten kroker	115 900
Silocut XL+ 225 skuffe	11256101Q	uten kroker	117 100
Silocut XL+ 250 skuffe	11256104Q	uten kroker	129 800
Tilbehør Silocut XL			
Plast og nett holder	11256084Q		5 900
Avskyver 225	11255107Q		23 100
Avskyver 250	11255108Q		24 500
Trykkbegrenser	60071811		2 800
Lasteventil/Trykkbegrenser	60040820		3 100
Sekvensventil Plast og nett holder	60071029		5 900
Slangesats Plast og nett holder	60071881		900
Sekvensventil Avskyver	60072002		5 900
Slangesats Avskyver	60071971		900
Slangesats. Längd 2250 mm med Tema 3/4"	10377059		2 700

MULTIBENNE S+



BoH
M16 S/L



over 190/210 bar
Trykkbegrenser
nødvendig

		90	100	120	140	160
Bredde	cm	90	100	120	140	160
Dybde	cm	86	86	86	86	86
Volum	m ³	0.38	0.43	0.52	0.62	0.71
Antall tenner		5	5	6	7	8
Vekt	kg	168	176	224	274	298
PRIS: Uten krok / slanger		14 700	15 000	18 700	19 300	20 500
Kroksats		2 100		2 100 / 3 400		
Sideplater		900				
Skjærstål HB500		2 200	2 500	2 900	3 300	3 700

Artikkelnummerliste
kroksatser se side 64



MULTIBENNE M+



Euro

BoH
M16 L

		130	150	170	190	210	230	250
Bredde	cm	130	150	170	190	210	230	250
Dybde	cm	80	80	80	80	80	80	80
Volum	mm	7	8	9	10	11	12	13
Antall tenner	m ³	0.66	0.76	0.86	0.96	1.07	1.17	1.27
Vekt	kg	280	304	360	386	423	447	477
PRIS: Sveiset krok***		30 300	32 300	34 000	35 200	37 400	38 900	40 600
PRIS: Uten krok/slanger		29 200	31 200	32 900	34 100	36 300	37 800	39 500
Kroksats		3 300						
Sideplater		Rette = 3 600 / Konvekse = 3 800						

Tilbehør:

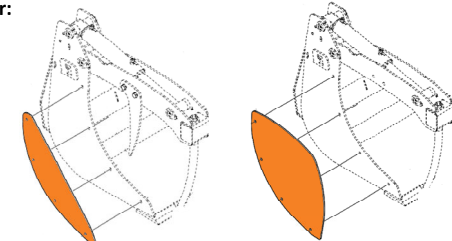

Rette

Konvekse

*** Versjonen med sveiset krok leveres komplett med slanger for tilkobling til Quicke-lastere

MULTIBENNE XL



Smidde tenner

Redskapet leveres uten spill beskyttelse og sideplater men med montert skjærstålsats.



over 250 bar
Trykkbegrenser
nødvendig

BoH
Rail L

		190	210	230	250
Bredde	cm	190	210	230	250
Dybde	cm	94.5	94.5	116.5	116.5
Høyde	cm	65	65	80	80
Volum, fylt og lukket	m ³	1.0	1.16	1.74	1.85
Vekt	kg	615	670	881	932
Skjærstål (BxT)	mm	190X20	190X20	250X25	250X25
PRIS: Uten krok / slanger		42 200	45 100	52 100	53 500
Kroksats		3 800			
Sideplater		1 800	1 800	1 800	1 800
Spill beskyttelse		2 100			



Redskap	Art.nr.	Kroktyp	Pris
Multibenne S+			
Multibenne S+ 90	11255715Q	uten kroker	14 700
Multibenne S+ 100	11255716Q	uten kroker	15 000
Multibenne S+ 120	11255717Q	uten kroker	18 700
Multibenne S+ 140	11255718Q	uten kroker	19 300
Multibenne S+ 160	11255719Q	uten kroker	20 500
Tilbehør Multibenne S+			
Skjærstålsats S+ 90	11255524Q		2 200
Skjærstålsats S+ 100	11255525Q		2 500
Skjærstålsats S+ 120	11255527Q		2 900
Skjærstålsats S+ 140	11255528Q		3 300
Skjærstålsats S+ 160	11255529Q		3 700
Sideplater Multibenne S+	11255725Q		900
Slangesats for tilkobling til Quicke frontlaster	60013335		900
Multibenne M+			
Multibenne M+ 130	11255825Q	uten kroker	29 200
Multibenne M+ 130	11255971Q	Euro	30 300
Multibenne M+ 150	11255853Q	uten kroker	31 200
Multibenne M+ 150	11255972Q	Euro	32 300
Multibenne M+ 170	11255857Q	uten kroker	32 900
Multibenne M+ 170	11255973Q	Euro	34 000
Multibenne M+ 190	11255858Q	uten kroker	34 100
Multibenne M+ 190	11255974Q	Euro	35 200
Multibenne M+ 210	11255859Q	uten kroker	36 300
Multibenne M+ 210	11255975Q	Euro	37 400
Multibenne M+ 230	11255860Q	uten kroker	37 800
Multibenne M+ 230	11255976Q	Euro	38 900
Multibenne M+ 250	11255862Q	uten kroker	39 500
Multibenne M+ 250	11255977Q	Euro	40 600

Redskap	Art.nr.	Kroktyp	Pris
Tilbehør Multibenne M+			
Sideplater rette Multibenne M+	11255841Q		3 600
Sideplater konvekse Multibenne M+	11255982Q		3 800
Trykkbegrenser	60002029		2 800
Lasteventil/Trykkbegrenser	60040820		3 100
Slangesats for tilkobling til Quicke frontlaster	60016632		900
Multibenne XL			
Multibenne XL 190 smidde tenner	11254802Q-S		42 200
Multibenne XL 210 smidde tenner	11254803Q-S		45 100
Multibenne XL 230 smidde tenner	11254804Q-S		52 100
Multibenne XL 250 smidde tenner	11254805Q-S		53 500
Tilbehør Multibenne XL			
Spill beskyttelse	11254786Q		2 100
Sideplater Multibenne XL 190-210	11254801Q		1 800
Sideplater Multibenne XL 230-250	11254787Q		1 800
Skjærstålsats Multibenne XL 190	11254153Q		4 700
Skjærstålsats Multibenne XL 210	11254154Q		5 000
Skjærstålsats Multibenne XL 230	11254826Q		6 800
Skjærstålsats Multibenne XL 250	11254998Q		7 000
Slangesats. Lengde 2250mm med Tema 3/4"	10377059		2 700

SILOGRAB S+



BoH
M16 S/L

		90	110	130	150
Bredde	cm	95	115	135	155
Dybde	cm	87.5	87.5	87.5	87.5
Høyde åpen	cm	127	127	127	127
Volum	m ³	0.43	0.52	0.62	0.71
Antall tenner		5+5	6+6	7+7	8+8
Vekt	kg	165	213	245	277
PRIS: Uten krok / slanger		13 900	17 300	18 700	20 000
Kroksats		2 100		A = 2 100 B = 3 300	

SILOGRAB M+



BoH
M16 L



		130	150	170	190	210	230	250
Bredde	cm	130	150	170	190	210	230	250
Dybde	cm	85	85	85	85	85	85	85
Volum	m ³	0.69	0.79	0.90	1.01	1.11	1.22	1.33
Antall tenner	mm	7+7	8+8	9+9	10+10	11+11	12+12	13+13
Vekt	kg	250	270	300	320	355	377	405
PRIS: Sveiset krok***		30 800	33 800	35 600	37 400	39 300	40 700	42 700
PRIS: Uten krok / slanger		28 600	31 600	33 400	35 200	37 100	38 500	40 500
Kroksats		3 300						
Trykkbegrenser		2 800						
Lasteventil/Trykkbegrenser		3 100						

*** Versjonen med sveiset krok leveres komplett med slanger for tilkobling til Quicke-lastere

SILOGRAB XL



F = Smidde tenner
P = Utskjærte tenner



BoH
Rail L

		190	210	230	250
Bredde	cm	190	210	230	250
Dybde	cm	120	120	140	140
Volum	m ³	1.0	1.1	1.7	1.9
Høyde lukket	cm	104	104	190	190
Høyde åpen	cm	185	185	190	190
Antall tenner		10	11	12	13
Vekt, F-versjon	kg	560	600	750	800
Vekt, P-versjon	kg	619	667	851	900
F – Uten krok / slanger		53 100	54 400	63 000	65 700
P – Uten krok / slanger		50 000	51 400	58 700	61 500
Kroksats		3 800			
Dekkplate		2 900			
Spill beskyttelse		2 100			



Artikkelnummerliste
kroksatser se side 64

Redskap	Art.nr.	Kroktyp	Pris
Silograb S			
Silograb S+ 90	11255720Q	uten kroker	13 900
Silograb S+ 110	11255721Q	uten kroker	17 300
Silograb S+ 130	11255722Q	uten kroker	18 700
Silograb S+ 150	11255723Q	uten kroker	20 000
Tilbehør Silograb S+			
Slangsats för anslutning till Quicke frontlastare.	60013335		900
Silograb M+			
Silograb M+ 130	11255842Q	uten kroker	28 600
Silograb M+ 130	11255964Q	Euro	30 800
Silograb M+ 150	11255908Q	uten kroker	31 600
Silograb M+ 150	11255965Q	Euro	33 800
Silograb M+ 170	11255909Q	uten kroker	33 400
Silograb M+ 170	11255966Q	Euro	35 600
Silograb M+ 190	11255911Q	uten kroker	35 200
Silograb M+ 190	11255967Q	Euro	37 400
Silograb M+ 210	11255913Q	uten kroker	37 100
Silograb M+ 210	11255968Q	Euro	39 300
Silograb M+ 230	11255914Q	uten kroker	38 500
Silograb M+ 230	11255969Q	Euro	40 700
Silograb M+ 250	11255915Q	uten kroker	40 500
Silograb M+ 250	11255970Q	Euro	42 700
Tilbehør Silograb M+			
Trykkbegrenser	60002029		2 800
Lasteventil/Trykkbegrenser	60040820		3 100
Slangsats för anslutning till Quicke frontlastare.	60016632		900

Redskap	Art.nr.	Kroktyp	Pris
Silograb XL			
Silograb XL 190 smidde tenner	11255049Q	uten kroker	53 100
Silograb XL 210 smidde tenner	11255059Q	uten kroker	54 400
Silograb XL 230 smidde tenner	11255060Q	uten kroker	63 000
Silograb XL 250 smidde tenner	11255053Q	uten kroker	65 700
Silograb XL 190 utskjærte tenner	11255050Q	uten kroker	50 000
Silograb XL 210 utskjærte tenner	11255051Q	uten kroker	51 400
Silograb XL 230 utskjærte tenner	11255052Q	uten kroker	58 700
Silograb XL 250 utskjærte tenner	11255062Q	uten kroker	61 500
Tilbehør Silograb XL			
Spill beskyttelse	11254786Q		2 100
Dekkplate	60027702		2 900
Slangsats. Längd 2250 mm med Tema 3/4"	10377059		2 700

SILOREDSKAP

Quicke

NEW

MULTIGRAB CS & C



		CS 120	C 120	C 140	C 170
Bredde	cm	124	124	139	172
Dybde	cm	51.6	59.8	59.8	59.8
Høyde	cm	64	74	74	74
Volume	m ³	0.22	0.3	0.34	0.42
Vekt	kg	90	133	141	161
PRIS: Sveiset krok		13 000	15 500	16 500	17 500
Sideplater		400	500		
Gripstål tannet		600		700	

Euro
Skid
steer

Tilbehør:

Sideplater



Gripstål tannet

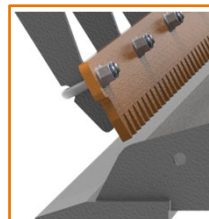

Sideplater + Gripstål



MULTIGRAB M+



BoH
M16 L

Tilbehør:

		200	220	240	260	Åpning
Bredde	cm	200	220	240	260	1 620 mm
Dybde	cm	121	121	121	121	
Høyde	cm	106	106	106	106	
Volume	m ³	1.30	1.45	1.60	1.75	
Vekt	Kg	560	589	673	694	
PRIS: Uten krok / slanger		43 500	45 500	50 000	51 500	
Kroksats		3 300				
Sideplater	1	1 300				
Gripstål rund	2	3 200	4 300			
Gripstål tannet	3	2 800	4 000			
Tann beskyttelse	4	900	1 200			
Sylindervern skrubart	5	1 400				
Skjærstål skuff		5 200	5 800	6 100	6 400	
Slanger Quickelastare		900				
Slanger 3/4" Tema 2250 mm		2 700				
Trykkbegrenser		2 800				
Lastholdningsventil/trykkbegrenser (6)		3 100 (tillgjengelig i 2024)				



NEW

Opp til
4.5
tonns
Løftekap-
asitet

Kompatibel med
lastmaskiner med Z-lenk

(1) Sideplater

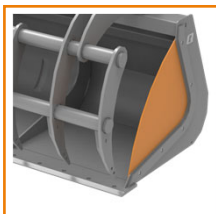

(2) Gripstål rund



(3) Gripstål tannet

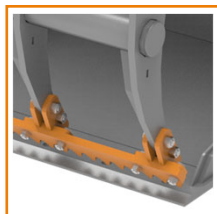

(4) Tann beskyttelse



(5) Sylindervern



Lasteventil/
Trykkbegrenser



Multigrab M+ er designet for bruk på frontlaster, mindre hjullastere og til medium teleskoplastere. Multigrab M+ er ideel for gjødsel, silo, resirkulerbare biomaterialer til industriavfall og lignende.

Artikkelnummerliste
kroksatser se side 64

Redskap	Art.nr.	Kroktyp	Pris
Multigrab C & CS			
Multigrab CS 120	11256338Q	Euro	13 000
Multigrab CS 120	11256399Q	Skidsteer	13 000
Multigrab C 120	11256286Q	Euro	15 500
Multigrab C 120	11256287Q	Skidsteer	15 500
Multigrab C 140	11256288Q	Euro	16 500
Multigrab C 140	11256289Q	Skidsteer	16 500
Multigrab C 170	11256313Q	Euro	17 500
Tillbehör Multigrab C & CS			
Sideplater Multigrab C	11256284Q		500
Grep stål C 120-140	11256285Q		600
Grep stål C 170	11256314Q		700
Grep stål CS 120	11256349Q		600
Sideplater Multigrab CS	11256350Q		400

Redskap	Art.nr.	Kroktyp	Pris
Multigrab M+			
Multigrab M+ 200	11256233Q	utan krokar	43 500
Multigrab M+ 220	11256234Q	utan krokar	45 500
Multigrab M+ 240	11256235Q	utan krokar	50 000
Multigrab M+ 260	11256236Q	utan krokar	51 500
Tillbehör Multigrab M+			
Grep stål rund 200-220	11256240Q		3 200
Grep stål rund 240-260	11256242Q		4 300
Grep stål tannet 200-220	11256244Q		2 800
Grep stål tannet 240-260	11256246Q		4 000
Tann beskyttelse 200-220	11256248Q		900
Tann beskyttelse 240-260	11256249Q		1 200
Sideplater	11256250Q		1 300
Sylindervern skrubart	11256251Q		1 400
Trykkbegreiser	60002029		2 800
Slangsats för anslutning till Quicke frontlastare	60016632		900
Slangsats. Längd 2250 mm med Tema 3/4"	60002021		2 700
Skjærstål 500 HB 200	11255494Q		5 200
Skjærstål 500 HB 220	11255495Q		5 800
Skjærstål 500 HB 240	11255496Q		6 100
Skjærstål 500 HB 260	11255497Q		6 400

GJØDSELGREP M+			130	150	170	190	230
	Bredde	cm	130	150	170	190	230
	Dybde	cm	85	85	85	85	85
	Antall tenner	st	7	8	9	10	12
	Vekt	kg	123	136	152	165	203
	PRIS: Sveiset krok		10 800	11 400	12 800	13 400	14 800
PRIS: Uten krok		9 700	10 300	11 700	12 300	13 700	
Kroksats				3 300			



BoH
M16 L

GJØDSELGREP XL			190	210	230	250
	Bredde	cm	187	209	229	249
	Dybde	cm	85	85	111	111
	Antall tenner	st	10	11	12	13
	Lengde på tenner	mm	995	985	1240	1240
	Vekt	kg	324	353	458	488
PRIS: Uten krok		27 300	30 000	33 000	35 700	

BoH
Rail L

Kroksats			3 800		
Dekkplate			2 900		
Spill beskyttelse			2 100		



Artikkelnummerliste
kroksatser se side 64

Redskap	Art.nr.	Kroktyp	Pris
Gjødselgrep			
Gjødselgrep M+ 130	11255916Q	uten kroker	9 700
Gjødselgrep M+ 130	11251838Q	Euro	10 800
Gjødselgrep M+ 150	11255929Q	uten kroker	10 300
Gjødselgrep M+ 150	11251848Q	Euro	11 400
Gjødselgrep M+ 170	11255930Q	uten kroker	11 700
Gjødselgrep M+ 170	11251858Q	Euro	12 800
Gjødselgrep M+ 190	11255931Q	uten kroker	12 300
Gjødselgrep M+ 190	11251868Q	Euro	13 400
Gjødselgrep M+ 230	11255932Q	uten kroker	13 700
Gjødselgrep M+ 230	11251878Q	Euro	14 800
Gjødselgrep XL			
Gjødselgrep XL 190	11255072Q	uten kroker	27 300
Gjødselgrep XL 210	11255073Q	uten kroker	30 000
Gjødselgrep XL 230	11255074Q	uten kroker	33 000
Gjødselgrep XL 250	11255075Q	uten kroker	35 700
Tilbehør Gjødselgrep XL			
Dekkplate	60027702		2 900
Spill beskyttelse	11254786Q		2 100

BALLEREDSKAP

Quicke

UNIGRIP™



Euro SMS



over 210 bar
Trykkgrensener
nødvendig

BoH
40x80

		130	160
Ballestørrelse min. – max.	cm	90 – 130	120 – 160
Vekt	kg	200	240
PRIS: Sveiset krok***		20 400	21 900
PRIS: Uten krok / slanger		17 400	18 900
Kroksats		2 100 / 3 800	
Slanger Quickelastere		900	
Trykkgrensener		2 100	
Lasteventil/Trykkgrensener		2 600	

FLEXIGRIP™



Euro SMS



over 210 bar
Trykkgrensener
nødvendig

BoH
40x80

		160	200
Ballestørrelse min. – max.	cm	120 – 160	150 – 200
Vekt	kg	262	287
PRIS: Sveiset krok***		25 200	39 100
PRIS: Uten krok / slanger		22 200	36 100
Kroksats		2 100 / 3 800	
Slanger Quickelastere		900	
Trykkgrensener		2 100	
Lasteventil/Trykkgrensener		2 600	

FLEXIBAL



Euro SMS



over 210 bar
Trykkgrensener
nødvendig

BoH
40x80

		89 MM RULLER	127 MM RULLER
Ballestørrelse	cm	180	180
Vekt	kg	195	195
PRIS: Sveiset krok***		22 400	22 400
PRIS: Uten krok / slanger		19 400	19 400
Kroksats		2 100 / 3 800	
Slanger Quickelastere		900	
Trykkgrensener		2 100	
Lasteventil/Trykkgrensener		2 600	

*** Versjonen med sveiset krok leveres komplett med slanger for tilkobling til Quicke-lastere



Artikkelnummerliste
kroksatser se side 64

Redskap	Art.nr.	Kroktyp	Pris
Unigrip			
Unigrip 130	11250778Q	Euro	20 400
Unigrip 130	11250775Q	SMS	20 400
Unigrip 130	11250770Q	uten kroker	17 400
Unigrip 160	11250788Q	Euro	21 900
Unigrip 160	11250785Q	SMS	21 900
Unigrip 160	11250780Q	uten kroker	18 900
Unigrip 160	11254946Q	Store BM	27 500
Tilbehør Unigrip			
Trykkbegrenser	60010270		2 100
Lasteventil/Trykkbegrenser	60040810		2 600
Slangsets för anslutning till Quicke frontlastare	10377022		900
Slangsets. Längd 2100 mm med Tema 3/4"	11214915		2 700
Flexigrip			
Flexigrip 160	11250798Q	Euro	25 200
Flexigrip 160	11250795Q	SMS	25 200
Flexigrip 160	11250700Q	uten kroker	22 200
Flexigrip 160	11254941Q	Store BM	30 800
Flexigrip 200	11250958Q	Euro	39 100
Flexigrip 200	11250400Q	uten kroker	36 100
Tilbehør Flexigrip			
Trykkbegrenser	60010270		2 100
Lasteventil/Trykkbegrenser	60040810		2 600
Slangsets för anslutning till Quicke frontlastare	10377023		900
Slangsets. Längd 2100 mm med Tema 3/4"	11214915		2 700

Redskap	Art.nr.	Kroktyp	Pris
Flexibal			
Flexibal 127 mm ruller	11250768Q	Euro	22 400
Flexibal 127 mm ruller	11250765Q	SMS	22 400
Flexibal 127 mm ruller	11250760Q	uten kroker	19 400
Flexibal 89 mm ruller	11253963Q	Euro	22 400
Flexibal 89 mm ruller	11253962Q	SMS	22 400
Flexibal 89 mm ruller	11253961Q	uten kroker	19 400
Tilbehør Flexibal			
Trykkbegrenser	60010270		2 100
Lasteventil/Trykkbegrenser	60040810		2 600
Slangsets för anslutning till Quicke frontlastare	10377308		900
Slangsets. Längd 2250 mm med Tema 3/4"	10377059		2 700

QUADROGRIP TS			135 cm armer	160 cm armer
 	Høyde	cm	53,5	53,5
	Ballestørrelse, max.	cm	200	200
	Ballestørrelse, min.	cm	65	65
	Bredde lukket	cm	175	175
	Bredde max åpen	cm	251	251
	Dybde	cm	180	205
	Vekt	cm	420	428
	Løftekapasitet	kg	1500	1500
PRIS: Uten krok / slanger			37 900	39 900
Kroksats			2 100 / 3 800	
Slinger Quickelastere			900	
Forhøyningssats			2 900	
Mengdereguleringsventil			2 100	
Trykkbegrenser			2 800	
Lasteventil/Trykkbegrenser			3 100	



over 210 bar
Trykkbegrenser
nødvendig

BoH
80x80

TOPGRIP			120	
	Ballestørrelse	cm	54 - 103	
	Vekt	kg	195	
	PRIS: Sveiset krok***			24 000
	PRIS: Uten krok / slanger			21 100
Kroksats			2 100 / 3 800	
Slinger Quickelastere			900	
Trykkbegrenser			2 100	
Lasteventil/Trykkbegrenser			2 600	



over 210 bar
Trykkbegrenser
nødvendig

BoH
80x80

*** Versjonen med sveiset krok leveres komplett med slanger for tilkobling til Quicke-lastere



BALLEREDSKAP

STORBALLEGREP S+



Euro

BoH
40x80

Leveres uten tinner

Bredde	cm	115
Høyde	cm	100
Max kapasitet	kg	1 000
Antall tinner kon 2		Opp til 3
Vekt	kg	98,5
PRIS: Sveiset krok		4 700
PRIS: Uten krok		4 400
Kroksats		2 100 / 3 800
Viktig: Velg tinne-sats i tabellen til høyre		

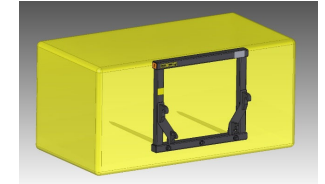
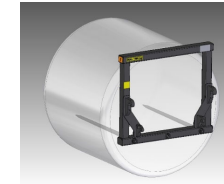
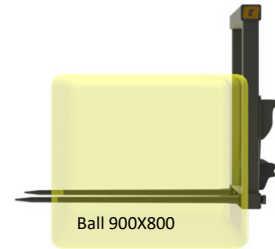

STORBALLEGREP M

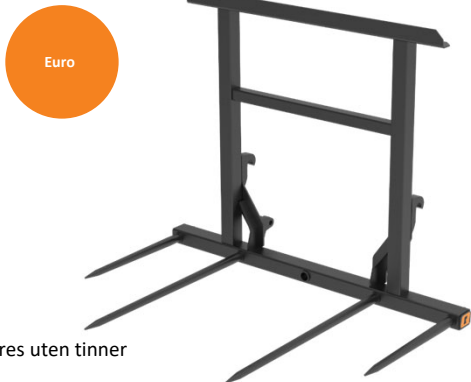

Euro

Leveres uten tinner

Bredde	cm	180
Høyde	cm	140
Max kapasitet	kg	2 000
Antall tinner kon 2		Opp til 5
Vekt	kg	135
PRIS: Sveiset krok		7 400
Viktig: Velg tinne-sats i tabellen til høyre		

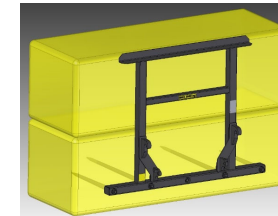
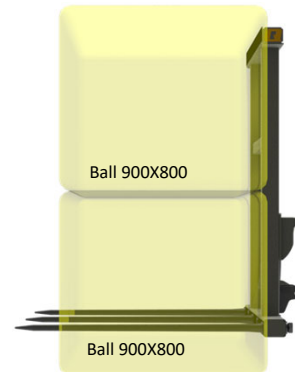

Tinne-satser

Tinne-sats 2 X 82 cm	2 000
Tinne-sats 3 X 82 cm	2 900
Tinne-sats 4 X 82 cm	3 800
Tinne-sats 5 X 82 cm	4 600
Tinne-sats 2 X 124 cm	2 100
Tinne-sats 3 X 124 cm	3 100
Tinne-sats 4 X 124 cm	4 000
Tinne-sats 5 X 124 cm	4 900

STORBALLEGREP L



Euro og
3-punkt

Leveres uten tinner

Bredde	cm	200
Høyde	cm	102
Max kapasitet	kg	2 500
Antall tinner kon 2		Opp til 5
Vekt	Kg	170
PRIS: Sveiset krok		10 200
Viktig: Velg tinne-sats i tabellen til høyre		

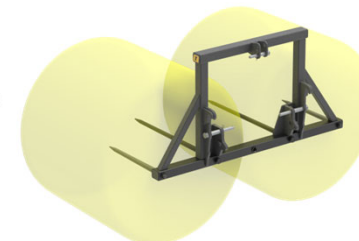
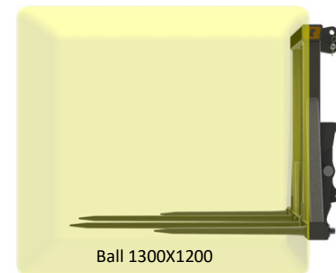

3-punkt Kategori 2 og 3

STORBALLEGREP L+

FAST TINNE-BJELKE

150

BoH
80x80

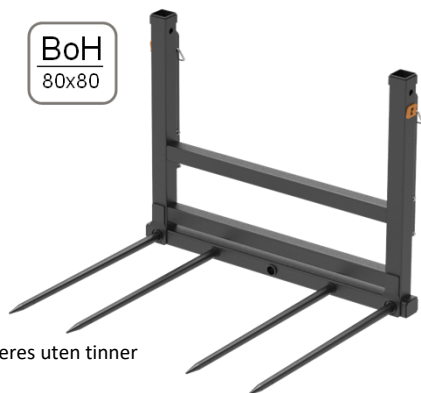

Leveres uten tinner

Bredde	cm	152,5
Høyde	cm	116,5
Max høyde med forhøyning	cm	176 / 184
Max kapasitet	kg	2 000
Antall tinner kon 2		Opp til 5
Vekt	kg	98

PRIS: Uten krok 7 500

Kroksats 2 100 / 3 800

Forhøyning med tinner (1) 2 900

Topp-bjelke til forhøyning (2) 1 500

Viktig: Velg tinne-sats i tabellen til høyre

STORBALLEGREP L+

OPPFELLBAR TINNE-BJELKE

150

BoH
80x80

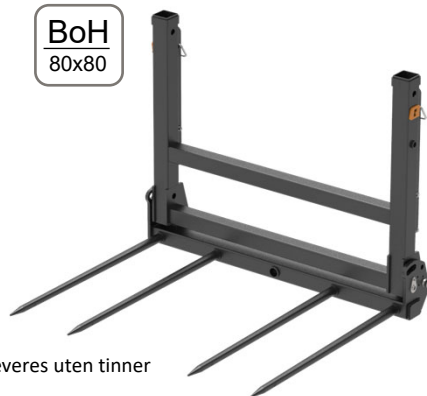

Leveres uten tinner

Bredde	cm	152,5
Høyde	cm	116,5
Max høyde med forhøyning	cm	176 / 184
Max kapasitet	kg	2 000
Antall tinner kon 2		Opp til 5
Vekt	kg	122

PRIS: Uten krok 9 500

Kroksats 2 100 / 3 800

Forhøyning med tinner (1) 2 900

Topp-bjelke til forhøyning (2) 1 500

Hydraulisk oppfellbar tinne-bjelke(3) 5 800

Viktig: Velg tinne-sats i tabellen til høyre



STORBALLEGREP L + 150 Oppfellbar tinne-bjelke med tre mulige posisjoner

1. Transport stilling, tinnene er låst mot redskapsryggen.
2. Arbeids stilling, tinnene kan bevege seg opp og ned.
3. Parkerings stilling, tinnene er låst horisontalt.

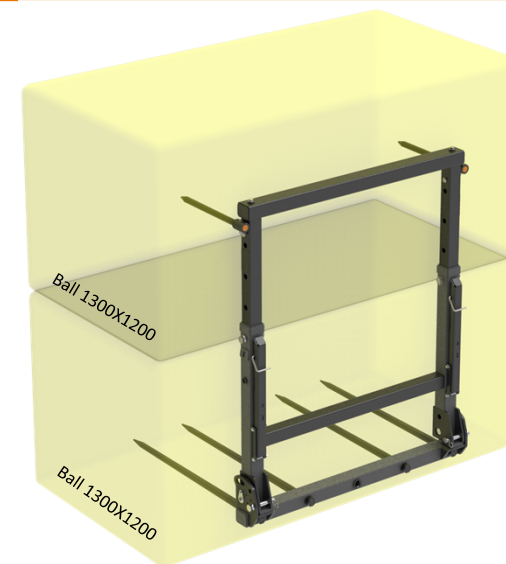
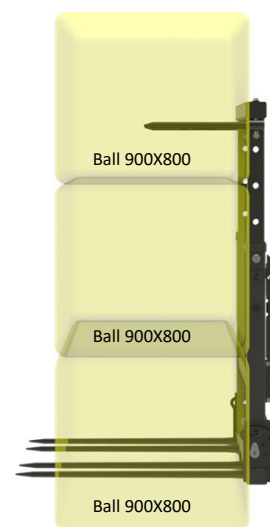

Tilbehør:

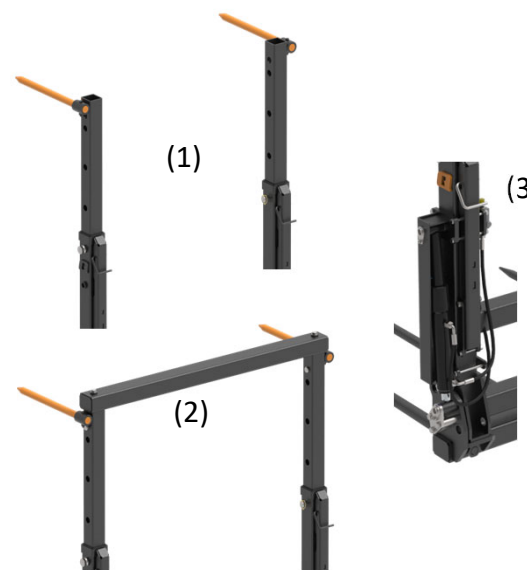

Tinne-satser

Tinne-sats 2 X 82 cm	2 000
Tinne-sats 3 X 82 cm	2 900
Tinne-sats 4 X 82 cm	3 800
Tinne-sats 5 X 82 cm	4 600
Tinne-sats 2 X 124 cm	2 100
Tinne-sats 3 X 124 cm	3 100
Tinne-sats 4 X 124 cm	4 000
Tinne-sats 5 X 124 cm	4 900

STORBALLEGREP XL+

OPPFELLBAR TINNE-BJELKE

200

BoH
80x80

Bildet viser redskap med alle tilbehør



Bredde	cm	200
Høyde	cm	176
Max høyde med forhøyning	cm	187 / 295
Max kapasitet	kg	2 500
Antall tinner kon 2		Opp till 5
Vekt	kg	157

PRIS: Uten krok **11 600**

Kroksats 2 100 / 3 800

Forhøyning med tinner (1) 3 500

Topp-bjelke til forhøyning (2) 1 500

Hydraulisk oppfellbar tinne-bjelke*(3) 5 800

Hydraulisk klo med tinner* (4) 10 700

2 stk oransje side tinner til hydr.klo (5) 700

Viktig: Velg tinne-sats i tabellen til høyre

Leveres uten tinner

* Slinger mellom redskap og frontlaster medfølger ikke.

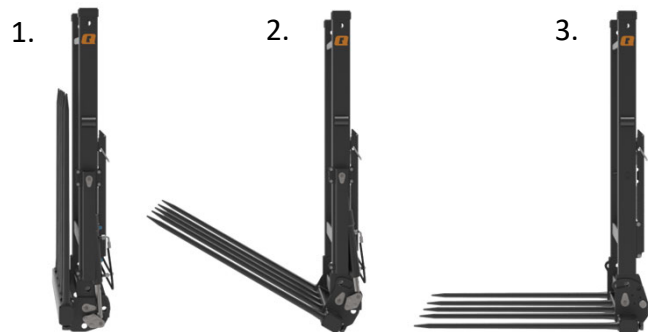

- STORBALLEGREP XL + 200 Oppfellbar tinne-bjelke med tre mulige posisjoner
1. Transportstilling, tinnene er låst mot redskapsryggen.
 2. Arbeidsstilling, tinnene kan bevege seg opp og ned.
 3. Parkeringsstilling, tinnene er låst horisontalt.

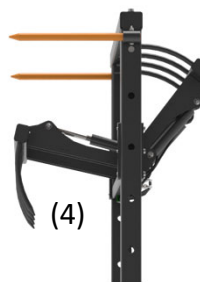
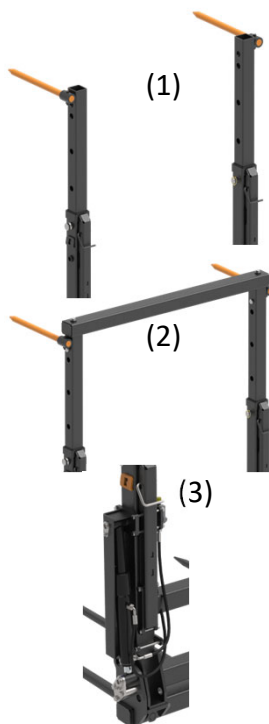

Greppinnsatser

Tinne-sats 2 X 82 cm	2 000
Tinne-sats 3 X 82 cm	2 900
Tinne-sats 4 X 82 cm	3 800
Tinne-sats 5 X 82 cm	4 600
Tinne-sats 2 X 124 cm	2 100
Tinne-sats 3 X 124 cm	3 100
Tinne-sats 4 X 124 cm	4 000
Tinne-sats 5 X 124 cm	4 900



Ball 1300X1200



Ball 900X800



Med hydraulisk klo



Ball 900X800



Ball 900X800

Redskap	Artikelnr.	Kroktyp	Pris
Storballegrep			
Storballegrep S+ 115	11255803Q	Euro	4 700
Storballegrep S+ 115	11256003Q	uten kroker	4 400
Storballegrep M 180	11255910Q	Euro	7 400
Storballegrep L 200	11255811Q	Euro / 3-punkt	10 200
Storballegrep L+ 150 fast tinne-bjelke	11256471Q	uten kroker	7 500
Storballegrep L+ 150 oppfellbar tinne-bjelke	11256472Q	uten kroker	9 500
Storballegrep XL+ 200 oppfellbar tinne-bjelke	11256469Q	uten kroker	11 600
Tilbehør Storballegrep			
Forhøyning med tinner Storballegrep L+ 150	60059576		2 900
Forhøyning med tinner Storballegrep XL+ 200	60058098		3 500
Topp-bjelke til forhøyning Storballegrep L+/XL+	60058097		1 500
Hydraulisk oppfellbar tinne-bjelke Storballegrep L+/XL+	60058100		5 800
Hydraulisk klo med tinner Storballegrep XL+ 200	60058088		10 700
2 stk oransje side tinner til hydr.klo XL+ 200	60060501		700
Tinne-satser			
Greptinnesats 2 X 82 cm	60038292		2 000
Greptinnesats 3 X 82 cm	60059952		2 900
Greptinnesats 4 X 82 cm	60039082		3 800
Greptinnesats 5 X 82 cm	60038290		4 600
Greptinnesats 2 X 124 cm	60038291		2 100
Greptinnesats 3 X 124 cm	60059951		3 100
Greptinnesats 4 X 124 cm	60039071		4 000
Greptinnesats 5 X 124 cm	60038289		4 900

BALLESPYD



Euro
SMS

BoH
40x80

Bredde	cm	127
Tinnelengde	cm	124
Vekt	kg	60
PRIS: Skrudd krok		6 600
PRIS: Uten krok		4 600
Kroksats		2 100 / 3 800

STORBALLEGREP M 140



Euro

		140- 2x82cm	140- 2x124cm
Bredde	cm	140	140
Lengde på tinner	cm	82	124
Antall tinner	cm	2	2
Vekt	kg	78	88
PRIS: Sveiset krok		7 300	7 500
Ryggforhøining		3 200	

SILOSPLIT



Euro
SMS
Typ 3

BoH
40x80

		120
Bredde	cm	120
Knivlengde	cm	170
Vekt	kg	110
PRIS: Skrudd krok		10 700
PRIS: Uten krok		8 600
Kroksats		2 100 / 3 800



Artikkelnummerliste
kroksatser se side 64

Redskap	Art.nr.	Kroktyp	Pris
Ballespyd			
Ballespyd	11254051Q	Euro	6 600
Ballespyd	11254371Q	SMS	6 600
Ballespyd	11254072Q	uten kroker	4 600
Storballegrep M 140			
Storballegrep M 140 2 X 82 cm tinner	11251577Q	Euro	7 300
Storballegrep M 140 2 X 124 cm tinner	11251578Q	Euro	7 500
Tilbehør Storballegrep M 140			
Ryggforhøyning	11215019Q		3 200
Silosplit			
Silosplit	11209793Q	Euro	10 700
Silosplit	11209792Q	SMS	10 700
Silosplit	11255115Q	Typ 3	10 700
Silosplit	11209790Q	uten kroker	8 600

PALLEGAFFEL C RAMMESTR 115 cm opp til 800 kg



Bredde (typ FEM II) Vekt*	cm kg	115,4 44	
PRIS RAMME:		5 900	
Gaffelben (typ FEM II B)		800 kg	
Lengde		800 mm	1060 mm
Dimensjon gaffelben	mm	80X32	80X32
Vekt pr par	kg	53	63
PRIS GAFFELBEN PAR:		2 600	2 900

Tilgjengelige kroker:
Euro
Skid Steer
Pin on (bare for Quicke C-serie laster)

**Vekt ramme Euro krok*

PALLEGAFFEL S RAMMESTR 100 cm opp til 2 500 kg For kompakt/små hjullastare

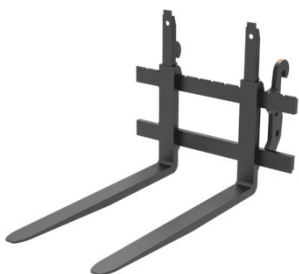

Bredde (typ FEM II) Vekt*	cm kg	100 45				
PRIS RAMME:		6 200				
Gaffelben (typ FEM II B)		1 000 kg		1 600 kg		2 500 kg
Lengde		970 mm	1220 mm	970 mm	1220 mm	1220 mm
Dimensjon gaffelben	mm	80X32	80X32	80X40	80X40	100X40
Vekt pr par	kg	62	72	74	86	107
PRIS GAFFELBEN PAR:		2 700	3 200	3 700	4 300	5 900
Tilbehør: Ballespyd		4 900				

Tilgjengelige kroker:
SMS**
Avant *
Euro (bredde ramme 120 cm)
Giant
Kramer Compact *
Weidemann
Schäffer Standard (SHW)
Schäffer Hoftrack
Zettelmeyer 402/Volvo L20.

** Kroken skal ikke brukes i kombinasjon med 2500 kg gaffelben*

**Vekt ramme Avant krok*

Tilbehør:



**** Kun for Euro/SMS**

PALLEGAFFEL M RAMMESTR 140 cm opp til 2 500 kg



Bredde (typ FEM II) Vekt*	cm kg	140 97				
PRIS RAMME:		7 100				
Gaffelben (typ FEM II B)		1 000 kg		1 600 kg		2 500 kg
Lengde		970 mm	1220 mm	970 mm	1220 mm	1220 mm
Dimensjon gaffelben	mm	80X32	80X32	80X40	80X40	100X40
Vekt pr par	kg	62	72	74	86	107
PRIS GAFFELBEN PAR:		2 700	3 200	3 700	4 300	5 900
Tilbehør: Griptilsats Ballespyd Hydraulisk gaffelspredning		13 100 4 900 13 500				

Tilgjengelige kroker:
Euro
SMS
MX
Skid Steer
Ålø Type 3
Alo Compact
Weidemann
Zettelmeyer 602/Volvo L30
Zettelmeyer 402/Volvo L20
Kramer Short
Schäffer Standard (SHW)
Dieci Small

**Vekt ramme Euro krok*

Tilbehør:

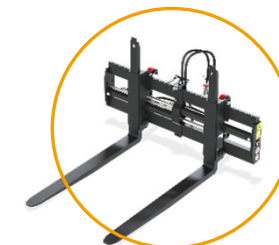

Griptilsats og ballespyd er ikke kompatibelt med hydraulisk gaffelspredning

Redskap	Art.nr.	Kroktyp	Pris
Pallgaffel C (Kompakt) gaffelramme			
Gaffelramme C Kompakt 800 kg	11255821Q	Pin-On	5 900
Gaffelramme C Kompakt 800 kg	11255815Q	Euro	5 900
Gaffelramme C Kompakt 800 kg	11255822Q	Skidsteer	5 900
Gaffelben Par 800 kg 800 mm	11255978Q		2 600
Gaffelben Par 800 kg 1060 mm	11255367Q		2 900
Pallgaffel S gaffelramme			
Gaffelramme S 2500 kg	11255707Q	Avant	6 200
Gaffelramme S 2500 kg (120 cm bred ramme)	11256058Q	Euro	7 100
Gaffelramme S 2500 kg	11255734Q	Giant	6 200
Gaffelramme S 2500 kg	11255704Q	Kramer Compact	6 200
Gaffelramme S 2500 kg	11255713Q	Schäffer Square	6 200
Gaffelramme S 2500 kg	11255712Q	Schäffer SWH	6 200
Gaffelramme S 2500 kg	11255735Q	SMS	6 200
Gaffelramme S 2500 kg	11255708Q	Weidemann	6 200
Gaffelramme S 2500 kg	11255724Q	Zettelmeyer 402	6 200
Tilbehør Pallgaffel S gaffelramme			
Ballespyd	11251754Q		4 900
Pallgaffel M gaffelramme			
Gaffelsats 1000 kg 970 mm	11252708Q	Euro	9 800
Gaffelsats 1000 kg 970 mm	11252305Q	SMS	9 800
Gaffelsats 1000 kg 970 mm	11252303Q	Typ 3	9 800
Gaffelsats 1000 kg 1220 mm	11252718Q	Euro	10 300
Gaffelsats 1000 kg 1220 mm	11252315Q	SMS	10 300
Gaffelsats 1000 kg 1220 mm	11252313Q	Typ 3	10 300
Gaffelsats 1600 kg 970 mm	11252728Q	Euro	10 800
Gaffelsats 1600 kg 970 mm	11252325Q	SMS	10 800
Gaffelsats 1600 kg 970 mm	11252323Q	Typ 3	10 800
Gaffelsats 1600 kg 1220 mm	11252738Q	Euro	11 400
Gaffelsats 1600 kg 1220 mm	11252335Q	SMS	11 400
Gaffelsats 1600 kg 1220 mm	11252333Q	Typ 3	11 400

Redskap	Art.nr.	Kroktyp	Pris
Gaffelsats 2500 kg 1220 mm	11252748Q	Euro	13 000
Gaffelsats 2500 kg 1220 mm	11252345Q	SMS	13 000
Gaffelsats hydraulisk 1600 kg 970 mm	11252378Q	Euro	24 300
Gaffelsats hydraulisk 1600 kg 1220 mm	11252388Q	Euro	24 900
Gaffelsats hydraulisk 2500 kg 1220 mm	11252398Q	Euro	26 500
Gaffelsats hydraulisk 2500 kg 1220 mm	11252395Q	SMS	26 500
Gaffelramme 1 000 kg, 1 600 kg og 2 500 kg	11262540Q	Euro	7 100
Gaffelramme 1 000 kg, 1 600 kg og 2 500 kg	11262339Q	Typ 3	7 100
Gaffelramme 1 000 kg, 1 600 kg og 2 500 kg	11262315Q	SMS	7 100
Gaffelramme 1 000 kg, 1 600 kg og 2 500 kg	11255378Q	Weidemann 8°	7 100
Gaffelramme 1 000 kg, 1 600 kg og 2 500 kg	11255981Q	Schäffer KR	7 100
Gaffelramme 1 000 kg, 1 600 kg og 2 500 kg	11262706Q	Alo Compact	7 100
Gaffelramme 1 000 kg, 1 600 kg og 2 500 kg	11262316Q	Skidsteer	7 100
Gaffelramme 1 000 kg, 1 600 kg og 2 500 kg	11253984Q	MX	7 100
Gaffelramme 1 000 kg, 1 600 kg og 2 500 kg	11255438Q	Dieci Small	7 100
Gaffelramme 1 000 kg, 1 600 kg og 2 500 kg	11255379Q	Weidemann 31°	7 100
Gaffelramme 1 000 kg, 1 600 kg og 2 500 kg	11255380Q	Zettelmeyer 602	7 100
Gaffelramme 1 000 kg, 1 600 kg og 2 500 kg	11255381Q	Zettelmeyer 602 24°	7 100
Gaffelramme 1 000 kg, 1 600 kg og 2 500 kg	11255382Q	Zettelmeyer 402	7 100
Gaffelramme 1 000 kg, 1 600 kg og 2 500 kg	11255383Q	Kramer short	7 100
Gaffelramme 1 000 kg, 1 600 kg og 2 500 kg	11255384Q	Schäffer Standard	7 100
Gaffelramme Hydraulisk 1600 kg, 2500 kg	11262586Q	Euro	20 600
Gaffelramme Hydraulisk 1600 kg, 2500 kg	11262602Q	SMS	20 600
Gaffelben Par 1000 kg 970 mm	11255355Q		2 700
Gaffelben Par 1000 kg 1220 mm	11255356Q		3 200
Gaffelben Par 1600 kg 970 mm	11255357Q		3 700
Gaffelben Par 1600 kg 1220 mm	11255358Q		4 300
Gaffelben Par 2500 kg 1220 mm	11255359Q		5 900
Tilbehør Pallgaffel M gaffelramme			
Griptilsats	11252211Q		13 100
Ballespyd	11251754Q		4 900
Hydraulisk gaffelspredning	11252050Q		13 500

PALLEGAFFEL L 3500 kg + 5000 kg RAMMEBREDDE 120 cm og 150 cm

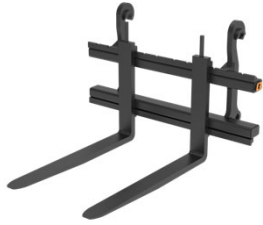

Bredde (typ FEM III)	cm	120		150	
PRIS RAMME:		9 400		10 200	
Gaffelben (typ FEM III A*)		3 500 kg		5 000 kg	
Lengde gaffelben		1220 mm	1500 mm	1220 mm	1500 mm
Dimensjon gaffelben	mm	125X45	125X45	150X50	150X50
ISO-standard gaffelben		3B	3A	3B	3B
Vekt pr par	kg	158	184	198	228
PRIS GAFFELBEN PAR:		7 000	7 300	11 900	13 000
Tilbehør:					
Gaffel forlengere		< 2000mm 4 400	< 2500mm 4 700	< 2000mm 7 700	< 2500mm 8 100

Tilgjengelige kroker:

Store BM

Bobcat / FDI / MF
Caterpillar CAT TH
Claas Scorpion
CNH LM
Dieci Medium
Dieci Large
Euro
JCB Q-Fit
JLG/Deutz Fahr
Kramer High
Manitou MLT
Matbro Pin and Cone,

Merlo ZM2
Merlo
Merlo ZM3 3PIN
Schäffer Standard
Schäffer HD (Type KR)
Weidemann
Weidemann 50-50
Zettelmeyer 602/Volvo L30

Tilbehør:



PALLEGAFFEL XL 8000 kg RAMMEBREDDE 200 cm

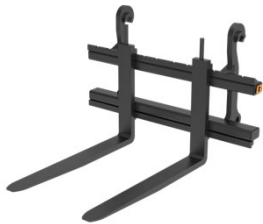

Bredde (typ FEM IIII)	cm	200	
PRIS RAMME:		15 200	
Gaffelben (typ FEM IIII A)		8 000 kg	
Lengde gaffelben		1220 mm*	1500 mm
Dimensjon gaffelben	mm	150X65	150X65
ISO-standard gaffelben		4A	4A
Vekt pr par	kg	272	316
PRIS GAFFELBEN PAR:		20 200	21 400
Tilbehør:			
Gaffel forlengere		< 2000mm 8 600	< 2500mm 10 600

Tilgjengelige kroker:

Store BM

JCB Q-FIT
Claas Scorpion
Manitou MLT
Merlo ZM3 3Pin

Tilbehør:



Redskap	Art.nr.	Kroktyp	Pris
Pallgaffel L gaffelramme 3500 kg / 5000 kg			
Gaffelramme 3500 kg / 5000 kg 120 cm Store BM	11255196Q		9 400
Gaffelramme 3500 kg / 5000 kg 120 cm Zettelmeyer 602	11255185Q		9 400
Gaffelramme 3500 kg / 5000 kg 150 cm Store BM	11255208Q		10 200
Gaffelramme 3500 kg / 5000 kg 150 cm Zettelmeyer 602	11255203Q		10 200
Gaffelben Par FEM 3B 3500 kg 1220 mm	11255389Q		7 000
Gaffelben Par FEM 3A 3500 kg 1500 mm	11255342Q		7 300
Gaffelben Par FEM 3B 5000 kg 1220 mm	11255391Q		11 900
Gaffelben Par FEM 3B 5000 kg 1500 mm	11255392Q		13 000
Tilbehør Pallgaffel L gaffelramme 3500 kg / 5000 kg			
Gaffel forlengere Par 3500 kg 2000 mm	11255395Q		4 400
Gaffel forlengere Par 3500 kg 2500 mm	11255396Q		4 700
Gaffel forlengere Par 5000 kg 2000 mm	11255397Q		7 700
Gaffel forlengere Par 5000 kg 2500 mm	11255398Q		8 100
Pallgaffel XL gaffelramme 8000 kg			
Gaffelramme 8000 kg 200 cm Store BM	11255215Q		15 200
Gaffelben Par FEM 4A 8000 kg 1220 mm	11255401Q		20 200
Gaffelben Par FEM 4A 8000 kg 1500 mm	11255402Q		21 400
Tilbehør Pallgaffel XL gaffelramme 8000 kg			
Gaffel forlengere Par 8000 kg 2000 mm	11255399Q		8 600
Gaffel forlengere Par 8000 kg 2500 mm	11255400Q		10 600

STORSEKKLØFT		SINGEL	DOBBEL	TRIPPEL	
	Bredde	cm	127	213	278
	Høyde min.	cm	164	170	170
	Høyde max.	cm	164	221	221
	Kapasitet (pr arm)	kg	1000	1500	1500
	Vekt	kg	79	177	269
PRIS: Skrudd krok			9 700	18 600	22 300
PRIS: Uten krok			7 600	14 800	18 500
Kroksats		2 100 / 3 800			



BoH
40x80

BoH
80x80

Storsekkløft singel: 40x80
 Storsekkløft dobbel: 80x80
 Storsekkløft trippel: 80x80

Euro
SMS
Typ3
Store
BM

3-PUNKTSFESTE		230
	Bredde	cm
	Dybde	cm
	Høyde	cm
	Vekt	kg
PRIS:		9 100

Max belastning
1 500 kg

Euro
SMS



Artikkelnummerliste
kroksatser se side 64

Redskap	Art.nr.	Kroktyp	Pris
Storsekkløft			
Storsekkeløft enkel	11254541Q	Euro	9 700
Storsekkeløft enkel	11254542Q	SMS	9 700
Storsekkeløft enkel	11254543Q	Typ 3	9 700
Storsekkeløft enkel	11254544Q	Store BM	11 400
Storsekkeløft enkel	11254361Q	uten kroker	7 600
Storsekkeløft dobbel	11254623Q	Euro	16 900
Storsekkeløft dobbel	11254624Q	SMS	16 900
Storsekkeløft dobbel	11254625Q	Store BM	18 600
Storsekkeløft dobbel	11254363Q	uten kroker	14 800
Storsekkeløft trippel	11254632Q	Store BM	22 300
Storsekkeløft trippel	11254364Q	uten kroker	18 500
3-punktsfeste			
3-punktsfeste	11251438Q	Euro	9 100
3-punktsfeste	11251435Q	SMS	9 100



STENGREP M+			155	200	225
	Bredde	cm	156	200	222
	Dybde	cm	111	111	111
	Høyde	cm	85	85	85
	Antall tinner		15	19	21
	Bredde frontpinne	mm	25	25	25
	Diameter tinner	mm	30	30	30
	Vekt	kg	242	318	348
	PRIS: Sveiset krok		20 100	21 800	24 100
	PRIS: Uten krok		18 000	19 700	22 000
	Kroksats		2 100 / 3 800		
3-punktsfeste		3 800			

Euro
SMS

BoH
60x80

STENGREP XL+			230	255	280
 	Bredde	cm	232	256	280
	Dybde	cm	160	160	160
	Høyde	cm	81	81	81
	Antall tinner		20	22	24
	Bredde frontpinne	mm	35	35	35
	Diameter tinner	mm	40	40	40
	Vekt	kg	730	876	942
	PRIS: Sveiset krok		44 400	53 200	60 200
	PRIS: Uten krok		39 200	48 000	55 000
	Kroksats		5 200		
Stenoppriever Store BM		3 100			
Stenoppriever boltbar		5 800			
3-punktsfeste Store BM		3 900			
3-punktsfeste boltbar		5 200			

Store
BM

BoH
80x80XL

Artikkelnummerliste
kroksatser se side 64

Redskap	Art.nr.	Kroktyp	Pris
Stengrep M+			
Stengrep M+ 155	11254857Q	Euro	20 100
Stengrep M+ 155	11254858Q	SMS	20 100
Stengrep M+ 155	11254856Q	uten kroker	18 000
Stengrep M+ 200	11254860Q	Euro	21 800
Stengrep M+ 200	11254861Q	SMS	21 800
Stengrep M+ 200	11254859Q	uten kroker	19 700
Stengrep M+ 225	11254863Q	Euro	24 100
Stengrep M+ 225	11254864Q	SMS	24 100
Stengrep M+ 225	11254862Q	uten kroker	22 000
Tilbehør Stengrep			
3-punktsfeste	11254879B		3 800
Stengrep XL			
Stengrep XL 230	11255319Q	uten kroker	39 200
Stengrep XL 230	11254866Q	Store BM	44 400
Stengrep XL 255	11255320Q	uten kroker	48 000
Stengrep XL 255	11254868Q	Store BM	53 200
Stengrep XL 280	11255321Q	uten kroker	55 000
Stengrep XL 280	11254870Q	Store BM	60 200
Tilbehør Stengrep XL			
Stenoppriver boltbar - Store BM	60021491		3 100
Stenoppriver boltbar - 80X80 XL	60037481		5 800
3-punktsfeste Store BM	60024323		3 900
3-punktsfeste 80X80 XL	11255325Q		5 200

MOTVEKTER & ADAPTERE

Q-BLOQ MOTVEKT		600	900	1800	600 (EKSTRAVEKT)
	Vekt	600	900	1800	600
	Kategori	Kat. 2	Kat. 2	Kat. 3N	
	PRIS:	20500	30000	62000	18500

Q-Bloq 600 kg ADD



Q-Bloq 600 kg



Q-Bloq 900 kg



Q-Bloq 1800 kg

ADAPTERE BOH 40X80		
	BOH 40X80 til Euro	10000
	Kombiner med våre skrubare kroker i 40X80-systemet.	Maks belastning: 3 000 kg

ADAPTERE		
	Euro til Typ 3	10200
	Euro til SMS	12100
	Euro til Lille BM	12100
	SMS til Typ 3	12100

MOTVEKT		800	1200
	Vekt, tom	186	212
	Vekt, full	800	1200
	PRIS:	10800	11100

Motvekten leveres tom.

Reguleres av – EN 12525:
Minst 20% av traktoren/lasterens bruttovikt skal være på bakakselen inklusive motvikten.

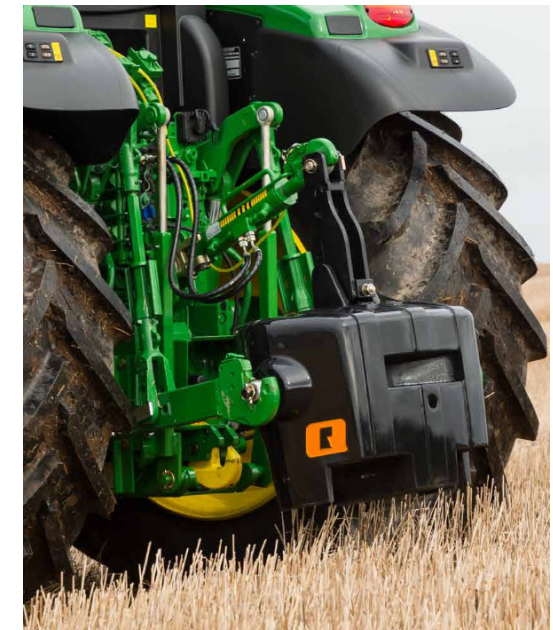

Redskap	Art.nr.	Kroktyp	Pris
Q-bloq motvekt			
Q-bloq 600 kg	11254142Q		20 500
Q-bloq 900 kg	11254143Q		30 000
Q-bloq 1800 kg	11254144Q		62 000
Q-bloq 600 kg tilleggsvekt	11254141Q		18 500
Motvekt (leveres tom)			
Motvekt fyllt 800 kg	11251676		10 800
Motvekt fyllt 1 200 kg	11251661		11 100
Adaptre BOH 40X80			
Adapter BOH 40X80 til Euro	11256336Q		10 000
Adaptre			
Adapter Euro til Typ 3	5201251		10 200
Adapter Euro til SMS	5201318		12 100
Adapter Euro til Lille BM	10830581		12 100
Adapter SMS til Typ 3	20529148		12 100

SKRUBARE KROKER - OVERSIKT

REDSKAP	ANTAL	40x80	80x80	60x80	80x80 XL	RAIL S	RAIL L	M24	M16
Ballespyd	1	X							
Flexibal	2	X							
Flexigrip	2	X							
Gjødselgrip XL	4						X		
Høytippende skuffe	5	X							
Klaffvingeskuff SC M+	1								X
Multibenne S+, M+	12								X
Multibenne XL	8						X		
Powergrab S	4					X			
Powergrab L+, XL+	4							X	
Quadrogrip TS	1		X						
Silocut M+	10		X						
Silocut L+	12		X						
Silocut XL+	6				X				
Silograb S+. M+	11								X
Silosplit	1	X							
Skuff SXL+, SL+, GXL+, GL+, VXL+, VL+	23							X	
Skuff SM+, GM+, GS+, VS+	15								X
Storballegrep S+	1	X							
Storballegrep L+, XL+	3		X						
Stengrep*	3			X					
Stengrep XL	3				X				
Storsekkløft (1, 2 og 3 løftearmer)*	3	X	X						
Topgrip	1		X						
Unigrip	2	X							

* 60x80 er samme krok som 40x80/80x80 men benytter M16 bolt med gjenget flattjern på baksiden

RAIL L:

M20 LANG BOLT

Gjødselgrep XL
Multibenne XL
Silograb XL

RAIL S:

M20 KORT BOLT

Powergrab S

40X80:

M16 - U-Bolt

Ballespyd MKII
Flexibal
Flexigrip
Høytippende skuffe
Silosplit
Storballegrep S+
Storsekkløft enkel

80X80:

M16 - U-Bolt

Quadrogrip TS
Silocut M+
Silocut L+
Storballegrep L+, XL+
Storsekkløft dobbel og trippel
Topgrip

80X80 XL:

M20 - U-Bolt

Stengrep XL
Silocut XL+

M24:

Skuffer SXL+, SL+, GXL+, GL+, VXL+, VL+
Powergrab L+, XL+

M16:

Skuffer SM+, GM+, GS+, VS+
Multibenne S+, Multibenne M+
Silograb S+, Multibenne M+
Klaffvingskuff SC M+



40x80/80x80



RAIL S/RAIL L



M24



80x80XL



M16 S
(opp til 2 ton
løftekapasitet)



M16 L
(opp til 3,7 t
løftekapasitet)

ARTIKKELLISTE KROKSATSER

Krokssystem: 40X80 / 60X80 / 80X80	Artikkelnr.	Pris
Stora BM	11254149X	3 800 kr
Euro	11254377X	2 100 kr
Euro -5° (Storballegrep L+ XL+)	11256057X	2 100 kr
SMS	11253940X	2 100 kr
TYP 3	11254509X	2 100 kr
A-ramme / Triangel	11256216X	3 800 kr
Atlas 95	11256380X	3 800 kr
Atlas 65 Storballegrep, Storsekkløft dobbel & trippel	11256499X	3 800 kr
Atlas 65 Silocut, Høytipp. skuffe, Storsekkløft singel, Storballegrep L+	11256500X	3 800 kr
Atlas 35	11256501X	3 800 kr
Avant	11256182X	2 100 kr
Bobcat/FDI/MF	11255102X	3 800 kr
Caterpillar Telehandler	11255142X	3 800 kr
Claas Scorpion	11253575X	3 800 kr
CNH LM	11255100X	3 800 kr
Dieci Small	11255237X	3 800 kr
Dieci Medium	11255236X	3 800 kr
Dieci Large	11255242X	3 800 kr
Giant	11255328X	2 100 kr
Hauer	11255143X	2 100 kr
JCB Qfit	11253571X	3 800 kr
JCB TC	11256274X	3 800 kr
JCB TC Compact	11255141X	3 800 kr
JLG / Deutz Fahr	11255240X	3 800 kr
Kramer Compact	11256068X	3 800 kr
Kramer Short	11255368X	3 800 kr
Kramer High	11255415X	3 800 kr
Lilla BM / Valtra	11255145X	2 100 kr
Manitou MLT	11253572X	3 800 kr
Matbro Pin & Cone	11253574X	3 800 kr
Merlo ZM2	11253573X	3 800 kr
Merlo ZM2S	11256460X	3 800 kr
Merlo ZM3 1 pin	11255137X	3 800 kr
Merlo ZM3 3 pin	11255138X	3 800 kr
M-X	11253971X	2 100 kr

Krokssystem: 40X80 / 60X80 / 80X80	Artikkelnr.	Pris
Schäffer Type KR	11255104X	3 800 kr
Schäffer HD Square	11255144X	2 100 kr
Schäffer Type SWH	11255232X	2 100 kr
Schäffer Square 336	11255636X	2 100 kr
Schäffer Square 442	11256269X	2 100 kr
Schäffer VM	11256163X	3 800 kr
Skidsteer	11254498X	2 100 kr
Terex Agrilift	11255243X	3 800 kr
Weidemann	11255106X	2 100 kr
Weidemann MV	11256113X	2 100 kr
Weidemann 50-50	11256226X	2 100 kr
Zettelmeyer 402	11255139X	3 800 kr
Zettelmeyer 602	11255429X	3 800 kr
Zettelmeyer 602 (JCB)	11255498X	3 800 kr
Zettelmeyer 602 (Høytipp. skuffe)	11255500X	3 800 kr
Zettelmeyer 602 (Claas)	11256253X	3 800 kr
Zettelmeyer 602 -26° (Claas)	11256254X	3 800 kr

Erstatt X i artikkelnr med:

Q for 40X80-kroker

B for 60X80-kroker (Stengrep M+)

A for 80X80-kroker

Artikkel nr er det samme men siste bokstav bestemmer type krok

11254377X i 40X80 Euro krok = 11254377Q

11254377X i 60X80 Euro krok = 11254377B

11254377X i 80X80 Euro krok = 11254377A

ARTIKKELLISTE KROKSATSER



Krokssystem: 80X80 XL	Artikkelnr.	Pris	Krokssystem: RAIL L	Artikkelnr.	Pris	Krokssystem: RAIL S	Artikkelnr.	Pris
Stora BM	11255111Q	5 200 kr	Stora BM	11254147A	3 800 kr	Stora BM	11254147Q	3 800 kr
Stora BM (extra undergraving)	11255463Q	5 200 kr	Euro	11254088A	3 800 kr	Euro 18°	11254088Q	3 800 kr
Euro	11255324Q	5 200 kr	SMS	11254223A	3 800 kr	SMS 27°	11254099Q	3 800 kr
Bobcat/FDI/MF	11255221Q	5 200 kr	Lilla BM / Valtra	11254374A	3 800 kr	Lilla BM / Valtra	11254374Q	3 800 kr
Claas Scorpion	11255187Q	5 200 kr	Bobcat/FDI/MF	11254112A	3 800 kr	Bobcat/FDI/MF	11254112Q	3 800 kr
Dieci Large	11255224Q	5 200 kr	Caterpillar AG2000	11255184A	3 800 kr	Claas Scorpion	11254123Q	3 800 kr
JCB Qfit	11255188Q	5 200 kr	Claas Scorpion	11254123A	3 800 kr	CNH LM	11255512Q	3 800 kr
Manitou MLT	11255189Q	5 200 kr	CNH LM	11255512A	3 800 kr	Dieci Small	11255238Q	3 800 kr
Matbro Pin & Cone	11255220Q	5 200 kr	Dieci Small	11255238A	3 800 kr	Dieci Medium	11255234Q	3 800 kr
Merlo ZM2	11255567Q	5 200 kr	Dieci Medium	11255234A	3 800 kr	Dieci Large	11255098Q	3 800 kr
Merlo ZM3 1 pin	11255191Q	5 200 kr	Dieci Large	11255098A	3 800 kr	Hauer	11254366Q	3 800 kr
Merlo ZM3 3 pin	11255190Q	5 200 kr	Hauer	11254366A	3 800 kr	JCB Qfit	11254125Q	3 800 kr
Schäffer Type KR	11255323Q	5 200 kr	JCB Qfit	11254125A	3 800 kr	JCB TC Compact	11255492Q	3 800 kr
Schäffer VM	11256218Q	5 200 kr	JCB TC Compact	11255492A	3 800 kr	JLG / Deutz Fahr	11255241Q	3 800 kr
Weidemann 50-50	11255322Q	5 200 kr	JLG / Deutz Fahr	11255241A	3 800 kr	Kramer Short	11255294Q	3 800 kr
Zettelmeyer 602	11255490Q	5 200 kr	Kramer Short	11255294A	3 800 kr	Kramer High	11255431Q	3 800 kr
Zettelmeyer 602 (for JCB)	11255491Q	5 200 kr	Kramer High	11255431A	3 800 kr	Manitou MLT 4,4°	11254124Q	3 800 kr
3-punkt feste	11255325Q	5 200 kr	Manitou MLT	11255273A	3 800 kr	Manitou MLT 21°	11255273Q	3 800 kr
			Matbro Pin & Cone	11254621A	3 800 kr	Matbro Pin & Cone 14°	11254621Q	3 800 kr
			Merlo ZM2	11255569A	3 800 kr	Merlo ZM2	11255569Q	3 800 kr
			Merlo ZM3 1 pin	11255096A	3 800 kr	Merlo ZM3 1 pin	11255096Q	3 800 kr
			Merlo ZM3 3 pin	11255095A	3 800 kr	Merlo ZM3 3 pin	11255095Q	3 800 kr
			M-X	11254800A	3 800 kr	M-X	11254800Q	3 800 kr
			Schäffer Type KR	11255823A	3 800 kr	Schäffer Type KR	11255823Q	3 800 kr
			Schäffer HD Square	11254568A	3 800 kr	Schäffer HD Square	11254568Q	3 800 kr
			Schäffer Type SWH	11255233A	3 800 kr	Schäffer Type SWH	11255233Q	3 800 kr
			Skidsteer	11254368A	3 800 kr	Skidsteer	11254368Q	3 800 kr
			Terex Agrilift	11255249A	3 800 kr	Terex Agrilift	11255249Q	3 800 kr
			Weidemann	11254087A	3 800 kr	Weidemann 28°	11254087Q	3 800 kr
			Zettelmeyer 402	11254086A	3 800 kr	Weidemann 5° (Powergrab)	11254827Q	3 800 kr
			Zettelmeyer 602	11254085A	3 800 kr	Zettelmeyer 402	11254086Q	3 800 kr
			Zettelmeyer 602 (for JCB)	11255510A	3 800 kr	Zettelmeyer 602	11254085Q	3 800 kr
			Zettelmeyer 602 (Claas)	11256239A	3 800 kr	Zettelmeyer 602 (for JCB)	11255510Q	3 800 kr
						Zettelmeyer 602 (Claas)	11256239Q	3 800 kr

ARTIKKELLISTE KROKSATSER



Krokssystem: M24	Artikelnr.	Pris	Krokssystem: M16S	Artikelnr.	Pris	Krokssystem: M16L	Artikelnr.	Pris
Stora BM	11255310Q	5 200 kr	Euro	11255560Q	2 100 kr	Stora BM	11255615Q	3 300 kr
Stora BM (extra undergrävning)	11255430Q	5 200 kr	SMS	11255579Q	2 100 kr	Euro	11255559Q	3 300 kr
Stora BM (extra uppbrytningsvinkel)	11255354Q	5 200 kr	Avant	11255578Q	2 100 kr	SMS	11255590Q	3 300 kr
Euro	11255468Q	5 200 kr	Giant	11255589Q	2 100 kr	Typ 3	11255624Q	3 300 kr
SMS	11255124Q	5 200 kr	Kramer Compact	11255572Q	2 100 kr	A-ramme / Triangel	11256217Q	3 300 kr
Atlas 65	11256506Q	5 200 kr	Schäffer Square 336	11255591Q	2 100 kr	Atlas 65 Skuffer med grep	11256505Q	3 300 kr
Atlas 95	11256356Q	5 200 kr	Schäffer Square 442	11256213Q	2 100 kr	Atlas 65 Skuffer	11255658Q	3 300 kr
Atlas 95 (redskap med gripdel)	11256601Q	5 200 kr	Schäffer Type SWH	11255561Q	2 100 kr	Atlas 35 Skuffer, Powergrab M+	11256502Q	3 300 kr
Bobcat/FDI/MF	11255307Q	5 200 kr	Weidemann	11255562Q	2 100 kr	Atlas 35 Silograb S+, Multibenne S+	11256503Q	3 300 kr
Caterpillar Telehandler	11255269Q	5 200 kr	Weidemann MV	11256027Q	2 100 kr	Atlas	11255658Q	3 300 kr
Claas Scorpion -5°	11255309Q	5 200 kr				Bobcat/FDI/MF	11255632Q	3 300 kr
Claas Scorpion 2°	11255663Q	5 200 kr				Caterpillar Telehandler	11255577Q	3 300 kr
CNH LM	11255511Q	5 200 kr				Claas Scorpion	11255612Q	3 300 kr
Dieci Small	11255271Q	5 200 kr				CNH LM	11255607Q	3 300 kr
Dieci Medium	11255265Q	5 200 kr				Dieci Small	11255629Q	3 300 kr
Dieci Large	11255261Q	5 200 kr				Dieci Medium	11255628Q	3 300 kr
Hauer	11256291Q	5 200 kr				Giant	11255585Q	3 300 kr
JCB Qfit	11255311Q	5 200 kr				JCB Qfit	11255617Q	3 300 kr
JCB Qfit Double Hook	11256282Q	5 200 kr				JCB TC Compact	11255635Q	3 300 kr
JCB TC Compact	11255134Q	5 200 kr				Kramer Short	11255610Q	3 300 kr
Kramer Short	11255274Q	5 200 kr				Manitou MLT	11255623Q	3 300 kr
Kramer High	11255413Q	5 200 kr				Matbro Pin & Cone	11255630Q	3 300 kr
Manitou MLT	11255308Q	5 200 kr				Merlo ZM2	11255618Q	3 300 kr
Matbro Pin & Cone	11255306Q	5 200 kr				Merlo ZM2S	11256458Q	3 300 kr
Merlo ZM2	11255570Q	5 200 kr				Schäffer Type KR	11255593Q	3 300 kr
Merlo ZM3 1 pin	11255260Q	5 200 kr				Schäffer Type SWH	11255588Q	3 300 kr
Merlo ZM3 3 pin	11255259Q	5 200 kr				Skidsteer	11255620Q	3 300 kr
M-X	11255121Q	5 200 kr				Weidemann	11255586Q	3 300 kr
Schäffer Type KR	11255263Q	5 200 kr				Weidemann 50-50	11255587Q	3 300 kr
Schäffer VM	11256130Q	5 200 kr				Zettelmeyer 402	11255616Q	3 300 kr
Skidsteer	11255992Q	5 200 kr				Zettelmeyer 602	11255558Q	3 300 kr
Weidemann	11255264Q	5 200 kr				Zettelmeyer 602 JCB	11255621Q	3 300 kr
Weidemann 50-50	11256305Q	5 200 kr				Zettelmeyer 602 (Claas)	11256191Q	3 300 kr
Zettelmeyer 602	11255270Q	5 200 kr						
Zettelmeyer 602 (för JCB)	11255470Q	5 200 kr						
Zettelmeyer 602 +8°(Claas)	11256192Q	5 200 kr						
Zettelmeyer 602 (Claas)	11256252Q	5 200 kr						

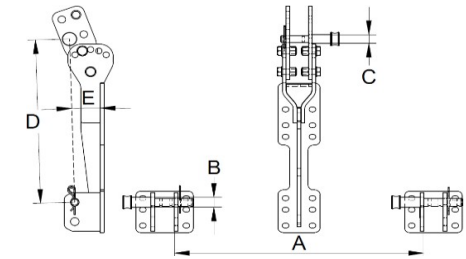

3-Point-Linkage (Category 2/2N/3)

Interface		A (Inner)	B (∅)	C (∅)	D (C-C)	PRISGRUPPE
Rail						
40x80/80x80	X	830/965 mm 32.7/38 in	25/31.5 mm 1/1.25 in	28/36.5 mm 1.1/1.44 in	610/685 mm 24/27 in	B
80x80 XL	X					
M24						
M16 S						
M16 L						

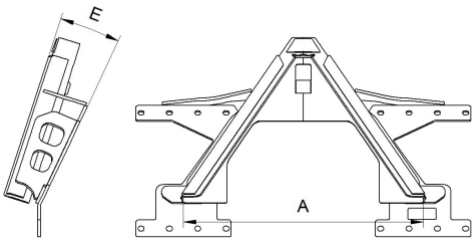

A-ram

Interface		A (Inner)	B (∅)	C (∅)	D (C-C)	PRISGRUPPE
Rail						
40x80/80x80	X	847 mm 33.3 in				B
80x80 XL						
M24						
M16 S						
M16 L	X					

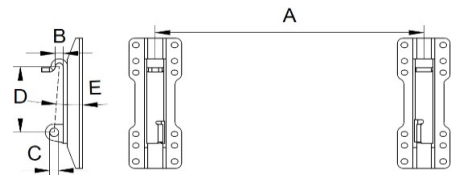

Ålö 3

Interface		A (Inner)	B (∅)	C (∅)	D (C-C)	PRISGRUPPE
Rail						
40x80/80x80	X	916 mm 36.06 in	27 mm 1.06 in	30.5 mm 1.20 in	237 mm 9.33 in	A
80x80 XL						
M24						
M16 S						
M16 L	X					

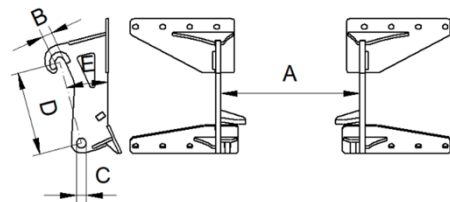

Atlas/Weycor 35

Interface		A (Inner)	B (∅)	C (∅)	D (C-C)	PRISGRUPPE
Rail						
40x80/80x80	X	514 mm 20.24 in	36 mm 1.42 in	36 mm 1.42 in	310 mm 12.20 in	B
80x80 XL						
M24						
M16 S						
M16 L	X					

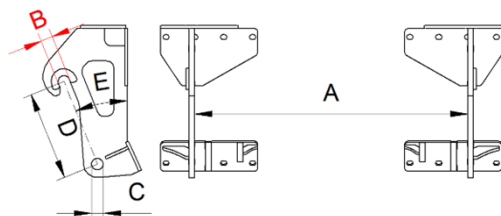

Atlas/Weycor 65

Interface		A (Inner)	B (∅)	C (∅)	D (C-C)	PRISGRUPPE
Rail						
40x80/80x80	X	946 mm 17.24 in	41 mm 1.61 in	41 mm 1.61 in	310 mm 12.20 in	B
80x80 XL						
M24	X					
M16 S	X					
M16 L						

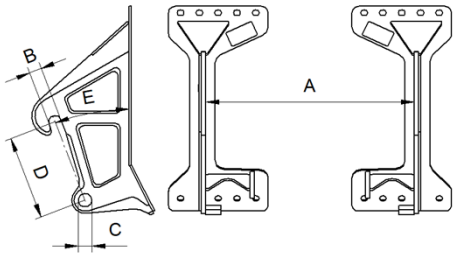

Atlas/Weycor 95

Interface		A (Indvendig)	B (∅)	C (∅)	D (C-C)	Prisgruppe
Rail						B
40x80/80x80	X					
80x80 XL		946 mm	56 mm	61 mm	380 mm	
M24	X	37.24 in	2.2 in	2.4 in	12.26 in	
M16 S						
M16 L						

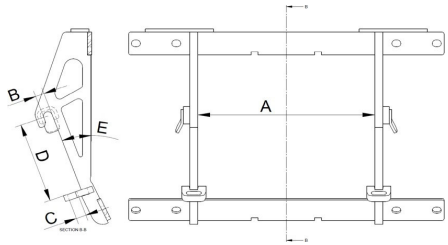

Avant

Interface		A (Indvendig)	B (∅)	C (∅)	D (C-C)	Prisgruppe
Rail						B
40x80/80x80	X					
80x80 XL		438 mm	22 mm	25 mm	211 mm	
M24		17.24 in	0.87 in	0.98 in	8.31 in	
M16 S	X					
M16 L						

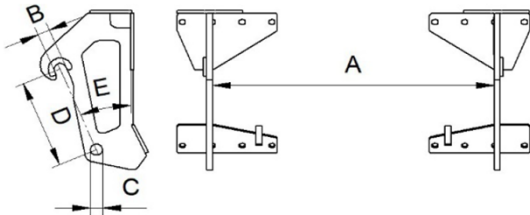

Bobcat / FDI / Massey Ferguson (MF)

Interface		A (Indvendig)	B (∅)	C (∅)	D (C-C)	Prisgruppe
Rail	X					B
40x80/80x80	X					
80x80 XL	X	765 mm	80 mm	38.25 mm	568.5 mm	
M24	X	30.12 in	3.15 in	1.51 in	2.24 in	
M16 S						
M16 L	X					

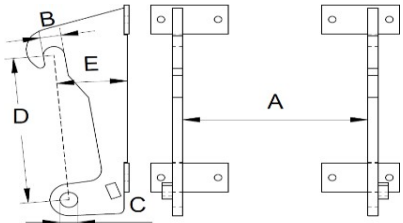

Caterpillar Telehandler

Interface		A (Indvendig)	B (∅)	C (∅)	D (C-C)	Prisgruppe
Rail	X	540 mm 21.26 in	62 mm 2.44 in	52 mm 2.05 in	505 mm 19.88 in	B
40x80/80x80	X					
80x80 XL						
M24	X					
M16 S						
M16 L	X					

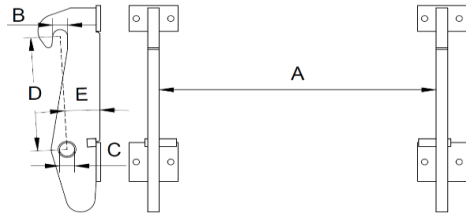

Claas Scorpion

Interface		A (Indvendig)	B (∅)	C (∅)	D (C-C)	Prisgruppe
Rail	X	960 mm 37.80 in	51 mm 2.01 in	52 mm 2.05 in	434.5 mm 17.11 in	B
40x80/80x80	X					
80x80 XL	X					
M24	X					
M16 S						
M16 L	X					

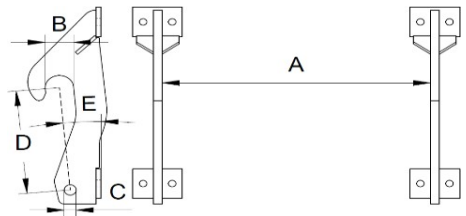

Case New Holland, CNH LM

Interface		A (Indvendig)	B (∅)	C (∅)	D (C-C)	Prisgruppe
Rail	X	765 mm 30.1 in	83 mm 3.27 in	35 mm 13.78 in	349.5 mm 1.38 in	B
40x80/80x80	X					
80x80 XL						
M24	X					
M16 S						
M16 L	X					

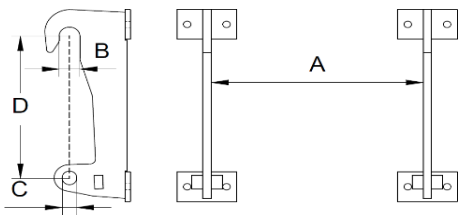

Dieci Small *

Interface		A (Indvendig)	B (∅)	C (∅)	D (C-C)	Prisgruppe
Rail	X	620 mm 24.41 in	61 mm 2.40 in	42 mm 1.65 in	482.4 mm 18.99 in	B
40x80/80x80	X					
80x80 XL						
M24	X					
M16 S						
M16 L	X					

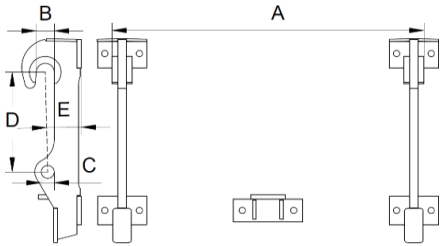

Dieci Medium *

Interface		A (Inner)	B (∅)	C (∅)	D (C-C)	PRISGRUPPE
Rail	X	1080 mm 42.52 in	62 mm 2.44 in	44 mm 1.73 in	350 mm 13.78 in	B
40x80/80x80	X					
80x80 XL						
M24	X					
M16 S						
M16 L	X					

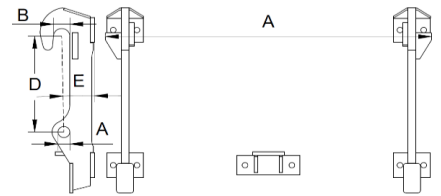

Dieci Large *

Interface		A (Inner)	B (∅)	C (∅)	D (C-C)	PRISGRUPPE
Rail	X	1240 mm 48.82 in	62 mm 2.44 in	44 mm 1.73 in	390 mm 15.35 in	B
40x80/80x80	X					
80x80 XL	X					
M24	X					
M16 S						
M16 L						

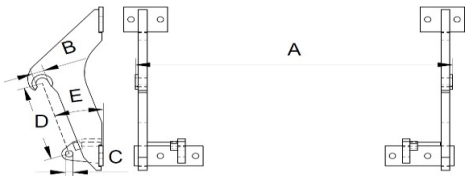

Euro

Interface		A (Inner)	B (∅)	C (∅)	D (C-C)	PRISGRUPPE
Rail	X	1080 mm 42.52 in	42 mm 1.65 in	26 mm 1.02 in	299 mm 11.77 in	A
40x80/80x80	X					
80x80 XL	X					
M24	X					
M16 S	X					
M16 L	X					

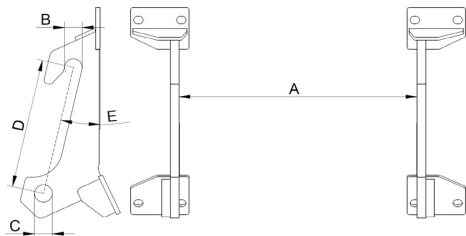

Giant

Interface		A (Inner)	B (∅)	C (∅)	D (C-C)	PRISGRUPPE
Rail		555 mm 21.85 in	41 mm 1.61 in	41,5 mm 1.63 in	310,5 mm 12.22 in	B
40x80/80x80	X					
80x80 XL						
M24						
M16 S	X					
M16 L	X					

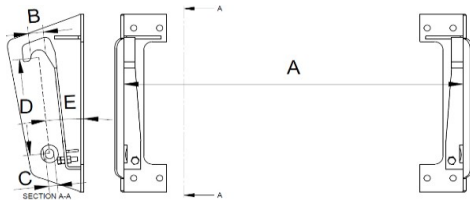

Hauer						
Interface		A (Inner)	B (∅)	C (∅)	D (C-C)	PRISGRUPPE
Rail	X	1110 mm 43.70 in	55 mm 2.17 in	30 mm 1.18 in	355 mm 13.98 in	A
40x80/80x80	X					
80x80 XL						
M24						
M16 S						
M16 L						

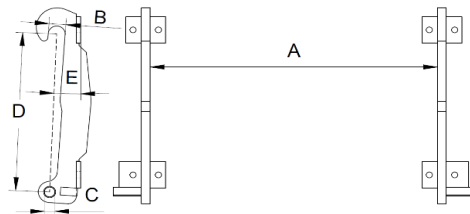

JCB Q-fit						
Interface		A (Inner)	B (∅)	C (∅)	D (C-C)	PRISGRUPPE
Rail	X	997 mm 39.25 in	60 mm 2.36 in	37 mm 1.46 in	600 mm 23.62 in	B
40x80/80x80	X					
80x80 XL	X					
M24	X					
M16 S						
M16 L	X					

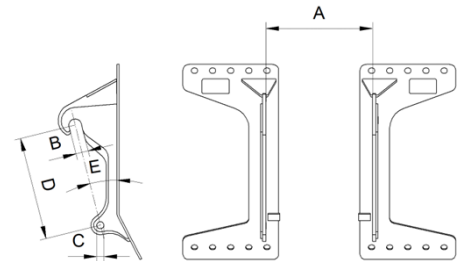

JCB TC						
Interface		A (Inner)	B (∅)	C (∅)	D (C-C)	PRISGRUPPE
Rail	X	500 mm 19.70 in	59 mm 2.3 in	34 mm 1.3 in	490 mm 19.3 in	B
40x80/80x80	X					
80x80 XL						
M24	X					
M16 S						
M16 L	X					

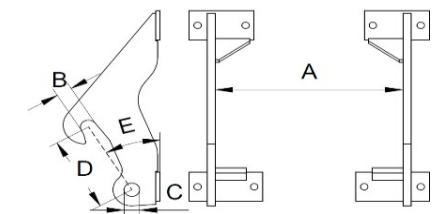

JCB TC Compact						
Interface		A (Inner)	B (∅)	C (∅)	D (C-C)	PRISGRUPPE
Rail	X	546 mm 21.50 in	47 mm 1.85 in	45.5 mm 1.79 in	248.5 mm 9.78 in	B
40x80/80x80	X					
80x80 XL						
M24	X					
M16 S						
M16 L	X					

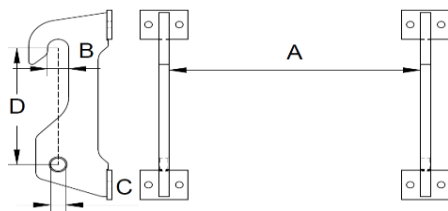

JLG / Deutz Fahr						
Interface		A (Inner)	B (∅)	C (∅)	D (C-C)	PRISGRUPPE
Rail	X	734 mm 28.90 in	62 mm 2.44 in	44 mm 1.73 in	399 mm 15.71 in	B
40x80/80x80	X					
80x80 XL						
M24						
M16 S						
M16 L						

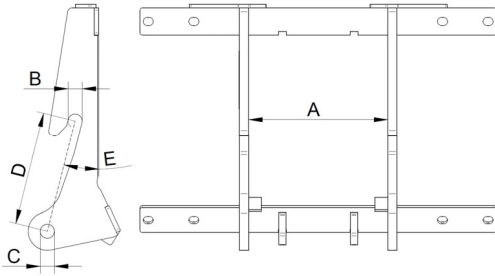

Kramer Compact

Interface		A (Inner)	B (∅)	C (∅)	D (C-C)	PRISGRUPPE
Rail						B
40x80/80x80	X	305 mm 12 in	31 mm 1.22 in	31 mm 1.22 in	251,5 mm 9.9 in	
80x80 XL						
M24						
M16 S	X					
M16 L						

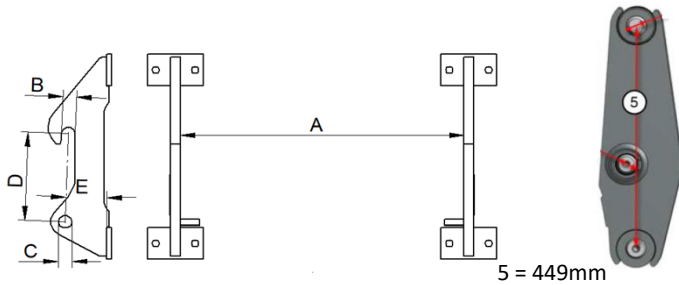

Kramer Short (mechanical stop)

Interface		A (Inner)	B (∅)	C (∅)	D (C-C)	PRISGRUPPE
Rail	X					B
40x80/80x80	X	865 mm 34.06 in	41 mm 1.6 in	41 mm 1.6 in	280 mm 11 in	
80x80 XL						
M24	X					
M16 S						
M16 L	X					

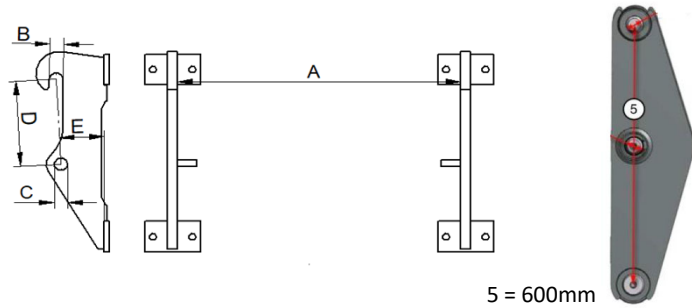

Kramer High (mechanical stop)

Interface		A (Inner)	B (∅)	C (∅)	D (C-C)	PRISGRUPPE
Rail	X					B
40x80/80x80	X	865 mm 34.06 in	41 mm 1.6 in	41 mm 1.6 in	280 mm 11 in	
80x80 XL						
M24	X					
M16 S						
M16 L	X					

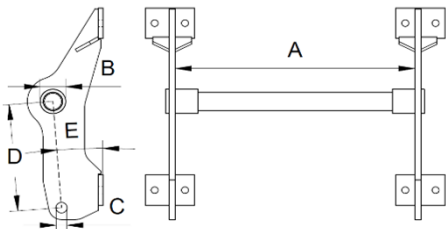

Manitou MLT

Interface		A (Inner)	B (∅)	C (∅)	D (C-C)	PRISGRUPPE
Rail	X					B
40x80/80x80	X	750 mm 29.53 in	80 mm 3.15 in	35 mm 1.38 in	351 mm 13.82 in	
80x80 XL	X					
M24	X					
M16 S						
M16 L	X					

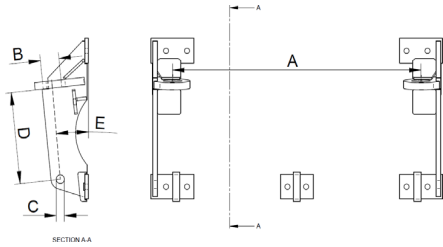

Pin og Cone (Matbro)

Interface		A (Inner)	B (∅)	C (∅)	D (C-C)	PRISGRUPPE
Rail	X					B
40x80/80x80	X					
80x80 XL	X	1068 mm	80 mm	35 mm	370 mm	
M24	X	42.05 in	3.15 in	1.38 in	14.57 in	
M16 S						
M16 L	X					

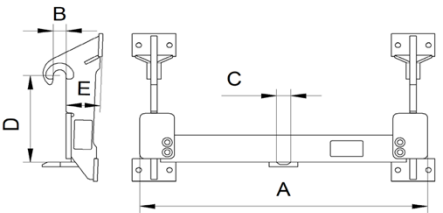

Merlo ZM2

Interface		A (Inner)	B (∅)	C (∅)	D (C-C)	PRISGRUPPE
Rail	X					B
40x80/80x80	X					
80x80 XL	X	1126 mm	51 mm	35 mm	384,5 mm	
M24	X	44.33 in	2.0 in	1.38 in	15.14 in	
M16 S						
M16 L	X					

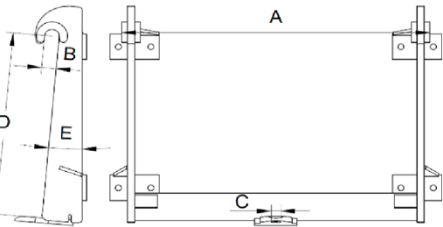

Merlo ZM3 1-pin

Interface		A (Inner)	B (∅)	C (∅)	D (C-C)	PRISGRUPPE
Rail	X					B
40x80/80x80	X					
80x80 XL	X	1090 mm	52 mm	35 mm	709 mm	
M24	X	42.91 in	2.05 in	1.38 in	27.91 in	
M16 S						
M16 L						

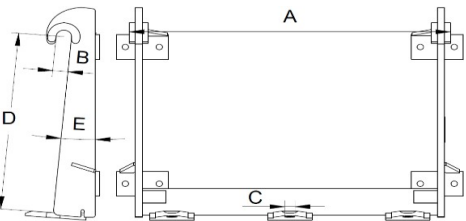

Merlo ZM3 3-pin

Interface		A (Inner)	B (∅)	C (∅)	D (C-C)	PRISGRUPPE
Rail	X					B
40x80/80x80	X					
80x80 XL	X	1090 mm	52 mm	35 mm	709 mm	
M24	X	42.91 in	2.05 in	1.38 in	27.91 in	
M16 S						
M16 L						

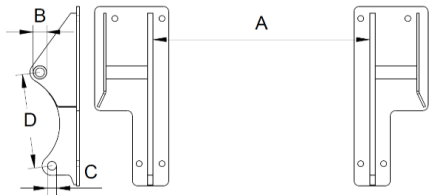

MX

Interface		A (Inner)	B (∅)	C (∅)	D (C-C)	PRISGRUPPE
Rail	X	805 mm 31.69 in	50 mm 1.97 in	33 mm 1.30 in	256.8 mm 10.11 in	A
40x80/80x80	X					
80x80 XL						
M24	X					
M16 S						
M16 L						

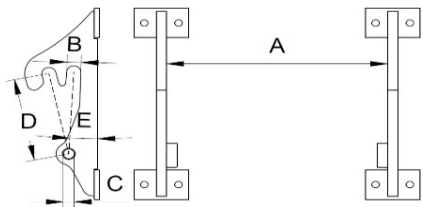

Schaffer Type SWH

Interface		A (Inner)	B (∅)	C (∅)	D (C-C)	PRISGRUPPE
Rail	X	645 mm 25.39 in	41 mm 1.61 in	32 mm 1.26 in	279.5 mm 11.00 in	A
40x80/80x80	X					
80x80 XL						
M24						
M16 S	X					
M16 L	X					

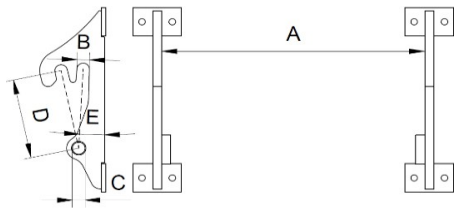

Schaffer Type KR

Interface		A (Inner)	B (∅)	C (∅)	D (C-C)	PRISGRUPPE
Rail	X	867 mm 34.13 in	41 mm 1.61 in	42 mm 1.65 in	279.5 mm 11.00 in	B
40x80/80x80	X					
80x80 XL	X					
M24	X					
M16 S						
M16 L	X					

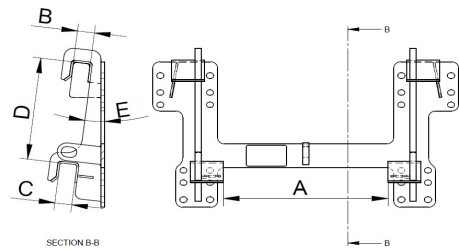

Schaffer Square 336

Interface		A (Inner)	B (∅)	C (∅)	D (C-C)	PRISGRUPPE
Rail		520 mm 20.47 in	54 mm 1.13 in	54 mm 1.13 in	345 mm 13.58 in	A
40x80/80x80	X					
80x80 XL						
M24						
M16 S	X					
M16 L						

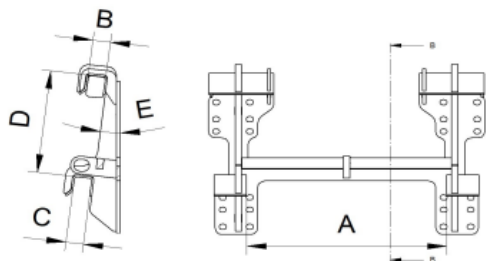

Schaffer Square 442

Interface		A (Inner)	B (∅)	C (∅)	D (C-C)	PRISGRUPPE
Rail		620 mm 24.40 in	54 mm 1.13 in	54 mm 1.13 in	345 mm 13.58 in	A
40x80/80x80	X					
80x80 XL						
M24						
M16 S	X					
M16 L						

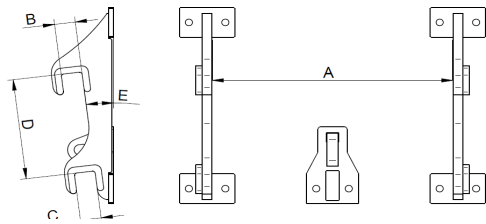

Schäffer HD Square

Interface		A (indvendig)	B (∅)	C (∅)	D (C-C)	Prisgruppe
Rail	X	740 mm 29.13 in	64 mm 2.52 in	64 mm 2.52 in	330 mm 12.99 in	A
40x80/80x80	X					
80x80 XL						
M24						
M16 S						
M16 L						

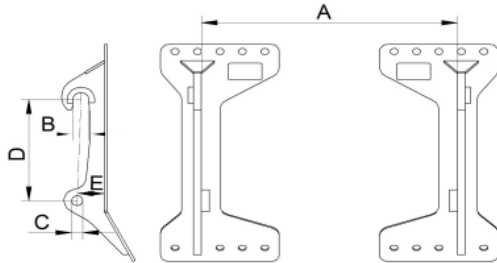

Schäffer VM

Interface		A (indvendig)	B (∅)	C (∅)	D (C-C)	Prisgruppe
Rail		970 mm 38.2 in	61 mm 2.4 in	42 mm 1.65 in	435 mm 17.10 in	A
40x80/80x80	X					
80x80 XL	X					
M24	X					
M16 S						
M16 L						

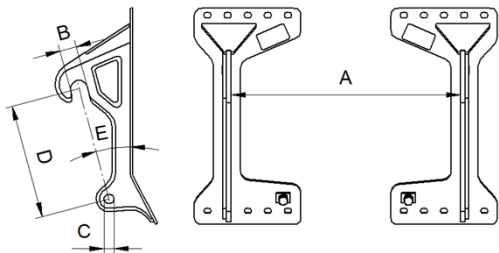

Sennebogen / Fendt

Interface		A (indvendig)	B (∅)	C (∅)	D (C-C)	Prisgruppe
Rail		970 mm 38.2 in	71 mm 2.8 in	41 mm 1.6 in	490 mm 19.3 in	A
40x80/80x80	X					
80x80 XL						
M24	X					
M16 S						
M16 L						

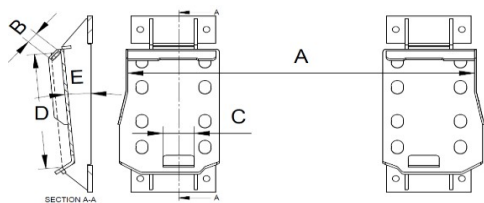

Skid-Steer

Interface		A (indvendig)	B (∅)	C (∅)	D (C-C)	Prisgruppe
Rail	X	1132 mm 44.57 in	40 mm 1.57 in	102 mm 4.02 in	422 mm 16.61 in	A
40x80/80x80	X					
80x80 XL						
M24						
M16 S						
M16 L	X					

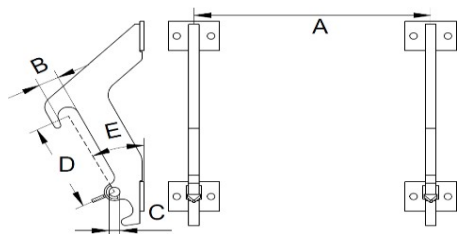

SMS

Interface		A (indvendig)	B (∅)	C (∅)	D (C-C)	Prisgruppe
Rail	X	690 mm 27.17 in	62 mm 2.44 in	32 mm 1.26 in	292 mm 11.50 in	A
40x80/80x80	X					
80x80 XL						
M24	X					
M16 S	X					
M16 L	X					

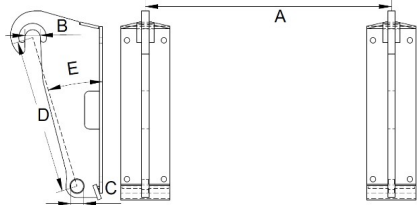

Volvo BM Large

Interface		A (Inner)	B (∅)	C (∅)	D (C-C)	PRISGRUPPE
Rail	X					B
40x80/80x80	X	1000 mm 39.37 in	62 mm 2.44 in	52.4 mm 2.06 in	616 mm 24.25 in	
80x80 XL	X					
M24	X					
M16 S						
M16 L	X					

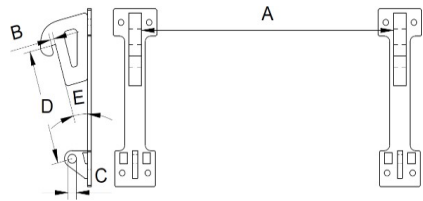

Volvo BM Small / Valtra

Interface		A (Inner)	B (∅)	C (∅)	D (C-C)	PRISGRUPPE
Rail	X					A
40x80/80x80	X	985 mm 38.78 in	16 mm 0.63 in	33 mm 1.30 in	420 mm 16.53 in	
80x80 XL						
M24						
M16 S						
M16 L						

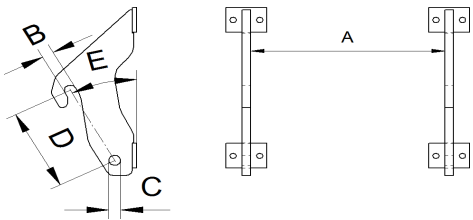

Weidemann

Interface		A (Inner)	B (∅)	C (∅)	D (C-C)	PRISGRUPPE
Rail	X					A
40x80/80x80	X	660 mm 25.98 in	36 mm 1.41 in	321.5 mm 12.66 in		
80x80 XL						
M24	X					
M16 S	X					
M16 L	X					

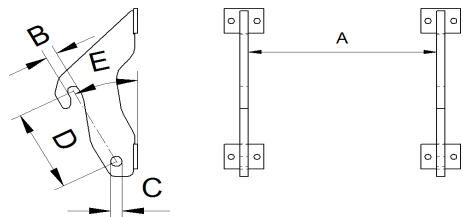

Weidemann 50-50

Interface		A (Inner)	B (∅)	C (∅)	D (C-C)	PRISGRUPPE
Rail	X					A
40x80/80x80		845 mm 33.27 in	50.5 mm 1.99 in	51 mm 2.01 in	322 mm 12.68 in	
80x80 XL	X					
M24						
M16 S						
M16 L	X					

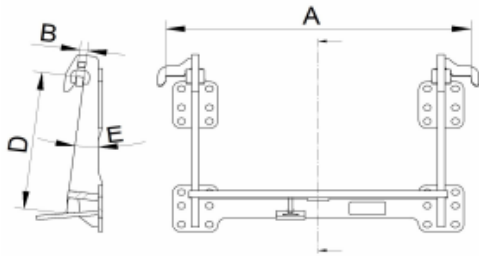

Weidemann MV

Interface		A (Inner)	B (∅)	C (∅)	D (C-C)	PRISGRUPPE
Rail						A
40x80/80x80	X					
80x80 XL		852 mm	50,5 mm		424 mm	
M24		33.5 in	1.99 in		16.68 in	
M16 S	X					
M16 L						

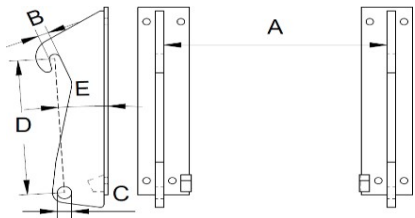

Zettelmeyer 402 / Volvo L20, L25

Interface		A (Inner)	B (∅)	C (∅)	D (C-C)	PRISGRUPPE
Rail	X					B
40x80/80x80	X					
80x80 XL		650 mm	32 mm	42 mm	464 mm	
M24		25.59 in	1.26 in	1.65 in	18.27 in	
M16 S						
M16 L	X					

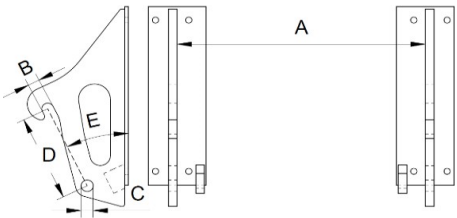

Zettelmeyer 602 / Volvo L30, L35

Interface		A (Inner)	B (∅)	C (∅)	D (C-C)	PRISGRUPPE
Rail	X					B
40x80/80x80	X					
80x80 XL	X	862 mm	41 mm	42 mm	311.5 mm	
M24	X	33.9 in	1.61 in	1.65 in	12.26 in	
M16 S						
M16 L	X					

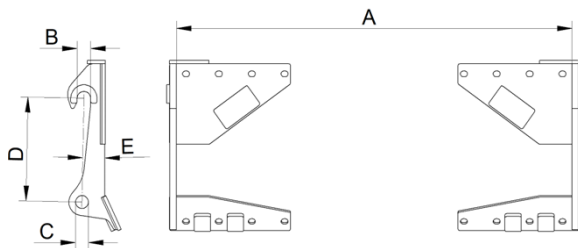

Älö HD

Interface		A (Inner)	B (∅)	C (∅)	D (C-C)	PRISGRUPPE
Rail						B
40x80/80x80						
80x80 XL		1203 mm	41 mm	39 mm	309 mm	
M24	X	47.36 in	1.61 in	1.53 in	12.2 in	
M16 S						
M16 L	X					

Quicke

Member of JOST World